

## 340nm UVC LED

- **SMD - medium power**
- **Chip on Board (COB)**
- **Applications Sets (LED, Heat Sink, Driver)**

 **Boston**Electronics

**[www.boselec.com](http://www.boselec.com)**

**[uv@boselec.com](mailto:uv@boselec.com)**

**[shop.boselec.com](http://shop.boselec.com)**

**617.566.3821**

## WS5252C40L3-340 Mid Power UVB LED SMD

**WS5252C40L3-340** is a UV LED Surface Mount Device (SMD) offering UV radiation at a peak wavelength of  $340\pm 5\text{nm}$ . The WS5252C40L3 series is packaged in a single-chip structure equipped with a  $30^\circ$  lens for mid power UV output. With its conventional pad structure and compact size, the WS5252C40L3 series is suitable for applications requiring mid UV output and energy consumption.

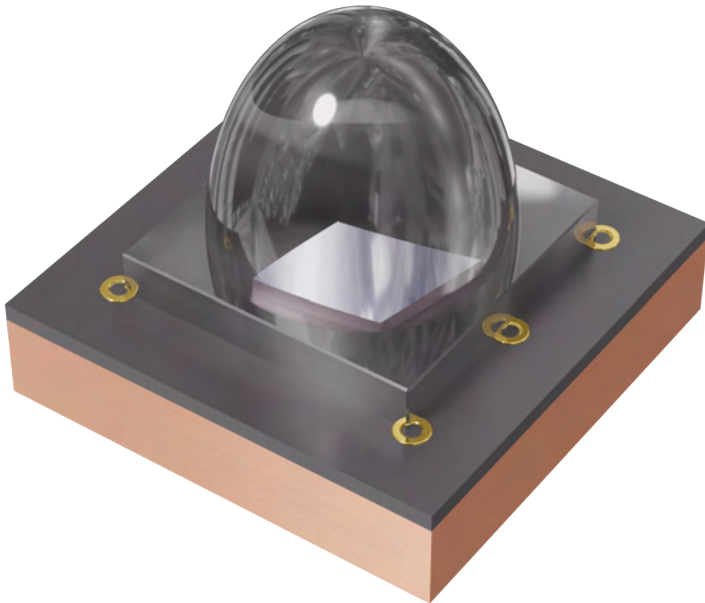

### FEATURES & BENEFITS

- Optical output up to 113mW
- Dimensions: 5.2x5.2mm
- Equipped with  $30^\circ$  fused silica lens
- Ideal for mid power applications

Electro-Optical Characteristics at T=25°C and I<sub>F</sub> = 350mA

Parameter	Symbol	Unit	Min	Typical	Max
Peak Wavelength	$\lambda_p$	nm	335	340	345
Forward Voltage	V <sub>F</sub>	V	5.2	5.5	5.7
Radiant Flux	P <sub>O</sub>	mW	85	113	135
Full Width of Half Magnitude	$\Delta\lambda$	nm	-	10.5	-
Radiant Angle	2 $\Phi_{1/2}$	Degree	-	30	-
Thermal Resistance, Junction to Solder Joint	R <sub>th</sub> (J-S)	°C/W	-	9	-

Absolute Maximum Ratings

Parameter	Symbol	Unit	Value
Forward Current	I <sub>F</sub>	mA	600
Reverse Voltage	V <sub>R</sub>	V	5
Power	P <sub>O</sub>	W	4
Junction Temperature	T <sub>J</sub>	°C	90
Operating Temperature	T <sub>OPR</sub>	°C	-30 ~ 85
Storage Temperature	T <sub>STG</sub>	°C	-40 ~ 85

Mechanical Dimensions

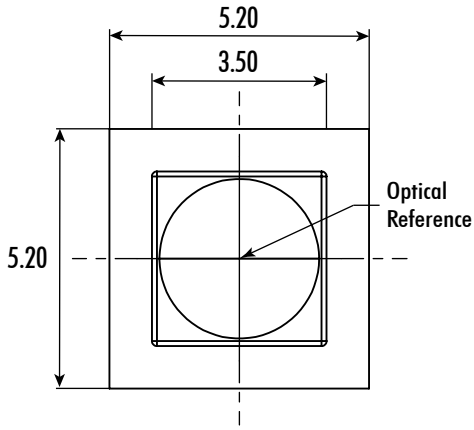

Top View

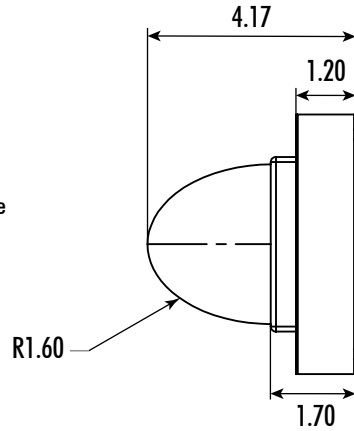

Side View

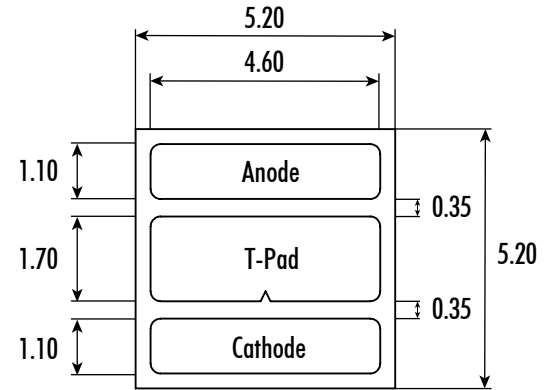

Bottom View

Radiation Pattern

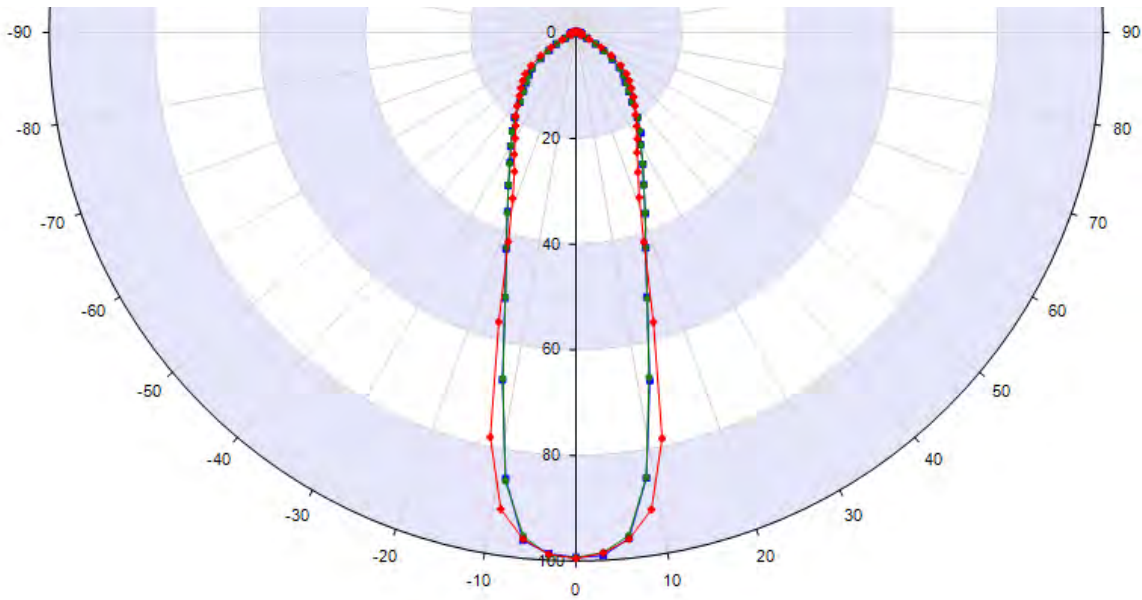

### Spectral Output

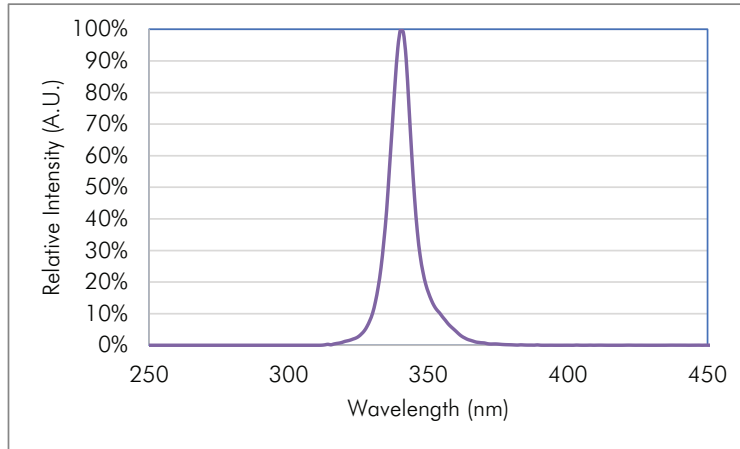

### Forward Current vs. Relative Radiant Flux

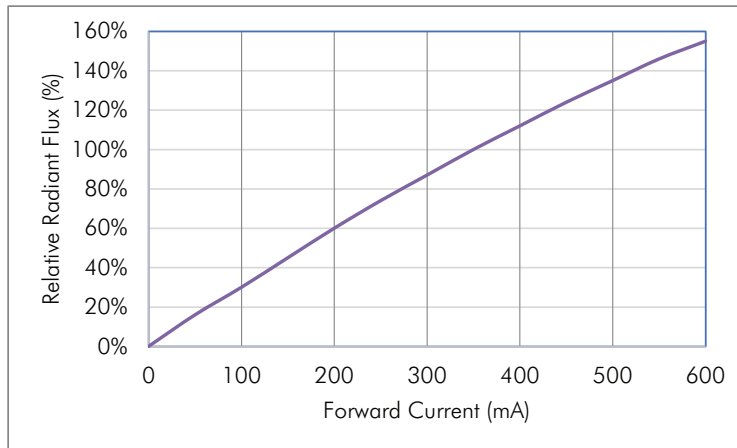

### Forward Voltage vs. Forward Current

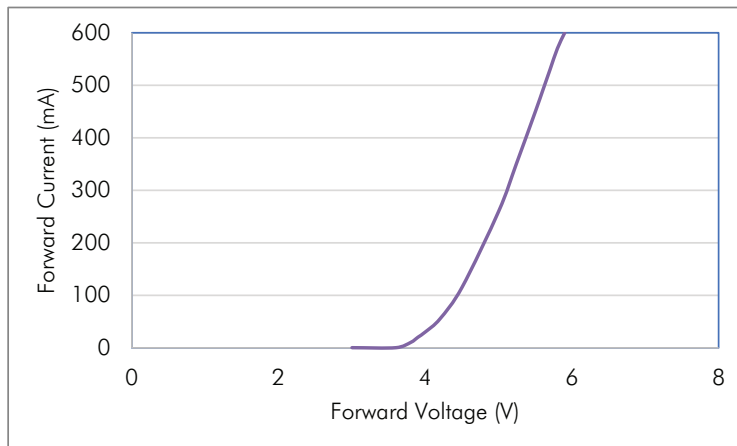

## Soldering Guidelines

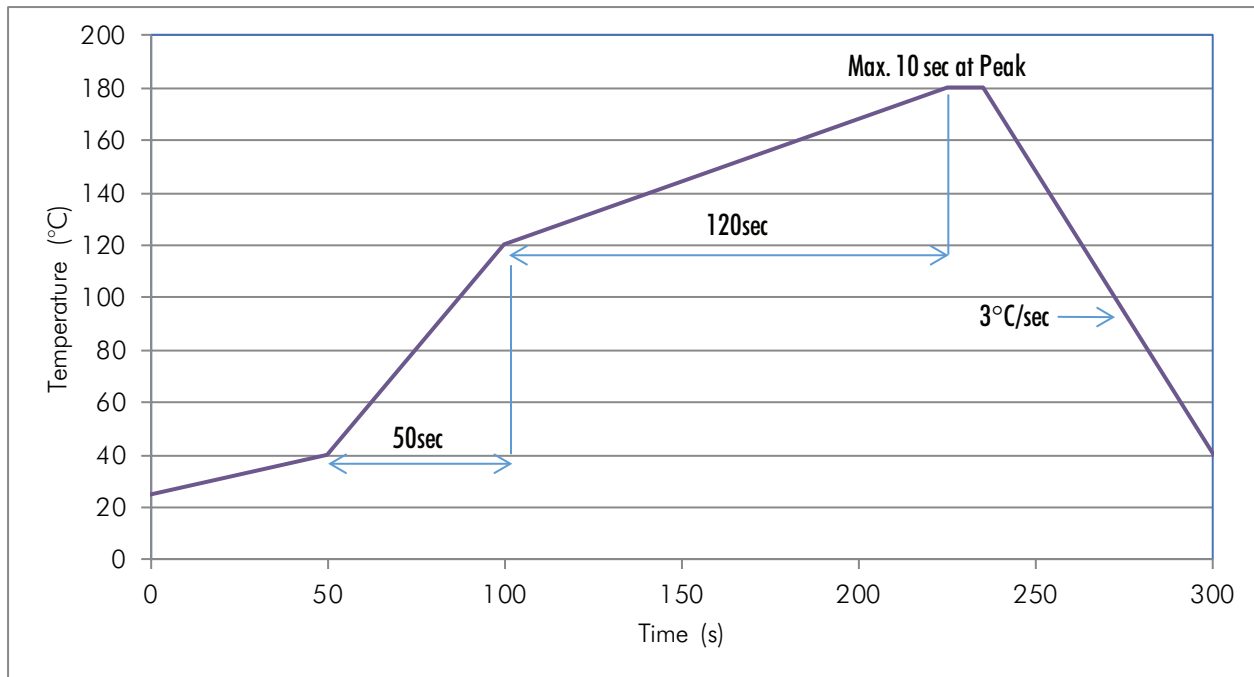

## Handling & Usage Precautions

- Exhibit extreme care when handling LEDs. Do not touch the LED with bare hands as doing so may contaminate and affect the optical characteristics of the LED. When using tweezers, do not apply excessive force, especially to the glass lens. Do not drop the LED as doing so may cause product damage.
- Ensure that electrostatic discharge specifications are followed. Static electricity and surge voltages may cause product damage. Proper electrostatic discharge protection equipment, working machinery, and protected mounting equipment are recommended.
- Do not expose the LEDs to volatile organic compounds as well as hazardous, acidic, and corrosive substances during storage and operation to avoid product damage.
- Do not apply excess mechanical force and vibration while handling the product.
- Do not expose the product to sudden changes in temperature, high humidity levels, and condensation.
- Ensure that the PCB is suitable for the product and be wary of LED placement and possible PCB warpage.

## Storage Precautions

- Perform soldering as soon as the moisture-proof packaging is opened.
- After the storage duration has exceeded the recommended time, products may need to be baked before soldering.
- Store all products in a controlled environment under 30° C free of dust. Do not expose the product to sudden changes in temperature, high humidity levels, and condensation.
- Please consult the Violumas engineering team for further information on storage precautions.

## Eye Safety Precautions

- Avoid exposure to UV light during LED operation. Do not look directly into the UV light during LED operation. Do not look directly into the UV light during optical measurements even through optical instruments. Protect the body, skin, and eyes with UV protective equipment.
- Attach warning labels on all products and systems that use UV LEDs.

## Cleaning Precautions

- Do not use brushes or organic solvents for cleaning the LEDs.
- Perform electrical and optical measurements before and after cleaning to ensure optimal performance.

## Static Electricity Precautions

- Ensure that equipment and machinery are properly grounded.
- Anti-electrostatic attire (wristbands, gloves, footwear, etc.) is recommended.
- Damage inspection is recommended while performing characteristics inspection of LEDs.

## Disclaimers

Violumas is not responsible for any damages that result from inaccurate use of the recommended guidelines. The information compiled in this document is a result of careful review of reference materials and reliable sources. Violumas does not make any claims regarding warranty or guarantee. It is recommended that each customer consults the Violumas engineering team before engaging Violumas products in extreme applications where the failure of the LED and damage to human health may be possible. Each user assumes full responsibility for determining the suitability of the use of Violumas products in various applications. Disassembling Violumas products without consent is prohibited. No part of these documents may be reproduced in any form without prior written permission from Violumas. Please note that the data presented in this document is measured from the use of exclusive Flip Chip Opto patented products - the 3-PAD LED Flip Chip and the Pillar MCPCB.

## WC1X1C40L3-340 Mid Power UVB LED COB

**WC1X1C40L3-340** is a UV LED Chip on Board (COB) module offering UV radiation at a peak wavelength of  $340\pm 5\text{nm}$ . The WC1X1C40L3 series is ready for plug and play with no soldering required and is equipped with a  $30^\circ$  lens for mid power UV output.

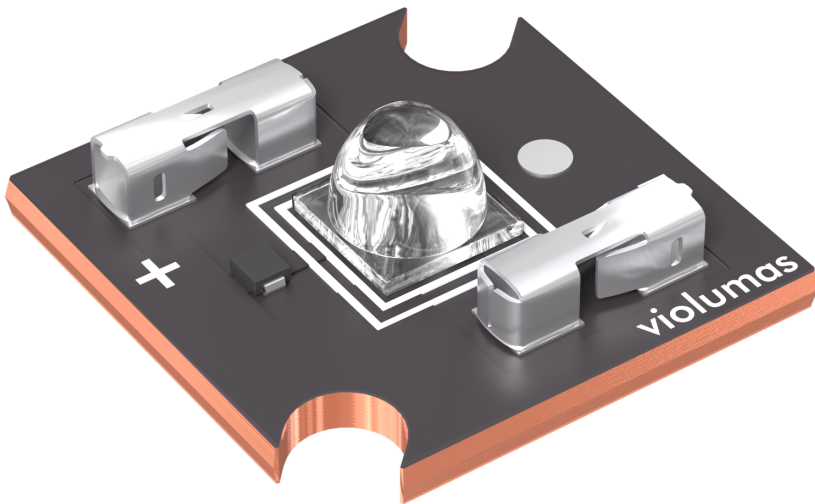

### FEATURES & BENEFITS

- Dimensions: 15x15x4.7mm
- Ready for plug and play (solder-free)
- Equipped with  $30^\circ$  fused silica lens
- TVS built in for ESD protection



Electro-Optical Characteristics at T=25°C and I<sub>F</sub> = 350mA

Parameter	Symbol	Unit	Min	Typical	Max
Peak Wavelength	$\lambda_p$	nm	340	345	350
Forward Voltage	V <sub>F</sub>	V	5.2	5.5	5.7
Radiant Flux	P <sub>O</sub>	mW	85	113	135
Full Width of Half Magnitude	$\Delta\lambda$	nm	-	10.5	-
Radiant Angle	2 $\Phi_{1/2}$	Degree	-	30	-
Thermal Resistance, Junction to Solder Joint	R <sub>th(J-S)</sub>	°C/W	-	9	-

Absolute Maximum Ratings

Parameter	Symbol	Unit	Value
Forward Current	I <sub>F</sub>	mA	600
Reverse Voltage	V <sub>R</sub>	V	5
Power	P <sub>O</sub>	W	4
Junction Temperature	T <sub>J</sub>	°C	90
Operating Temperature	T <sub>OPR</sub>	°C	-30 ~ 85
Storage Temperature	T <sub>STG</sub>	°C	-40 ~ 85

## Product Overview

COB modules are ready for plug and play with no soldering required. All Violumas COBs are equipped with connectors for direct wiring and TVS protection against ESD and voltage issues.

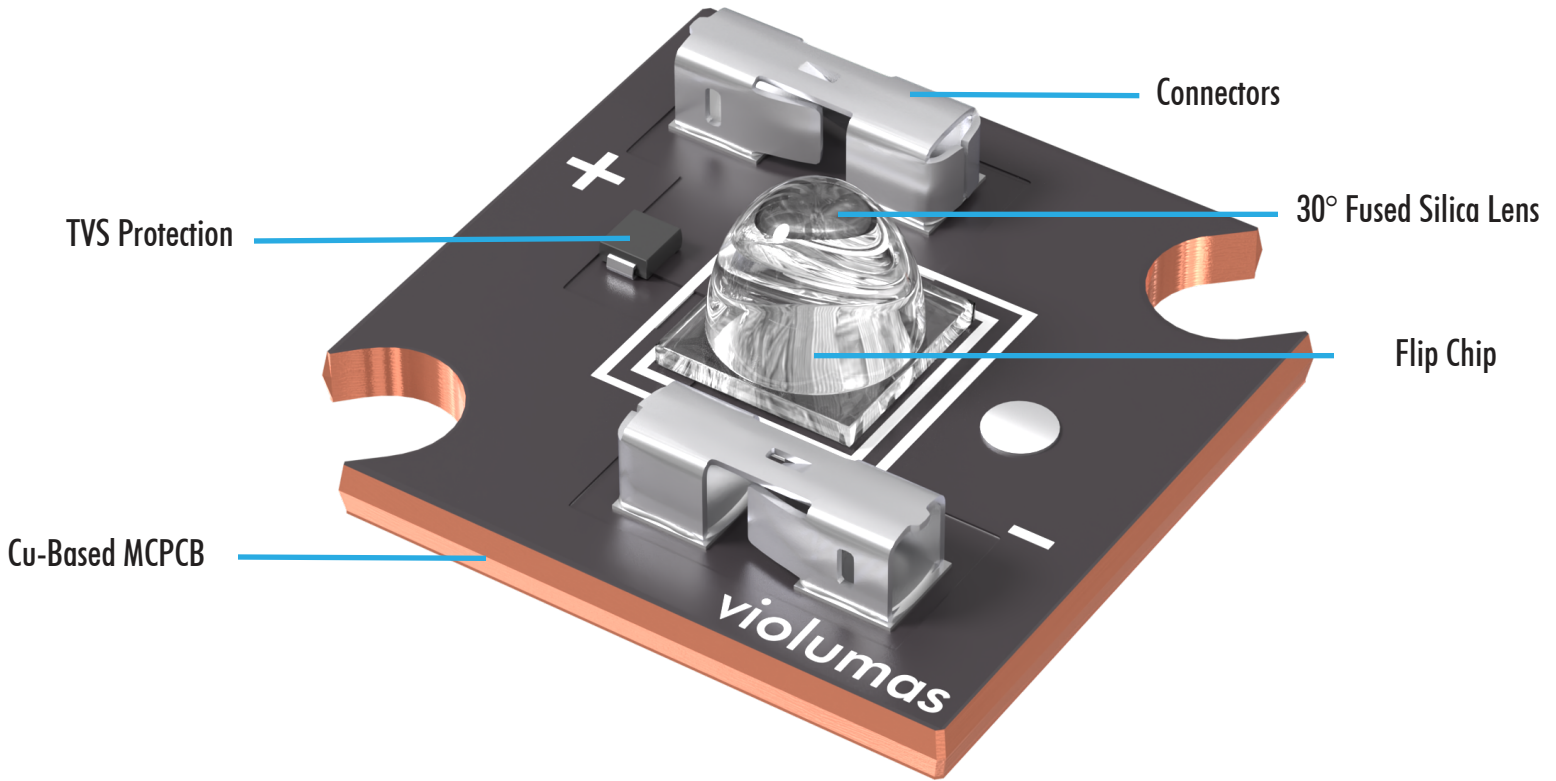

### Radiation Pattern

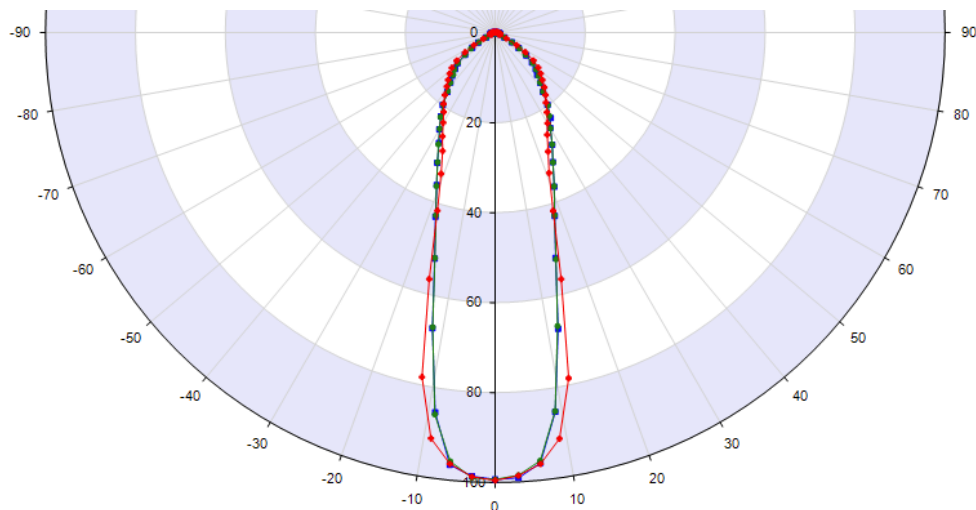

## Spectral Output

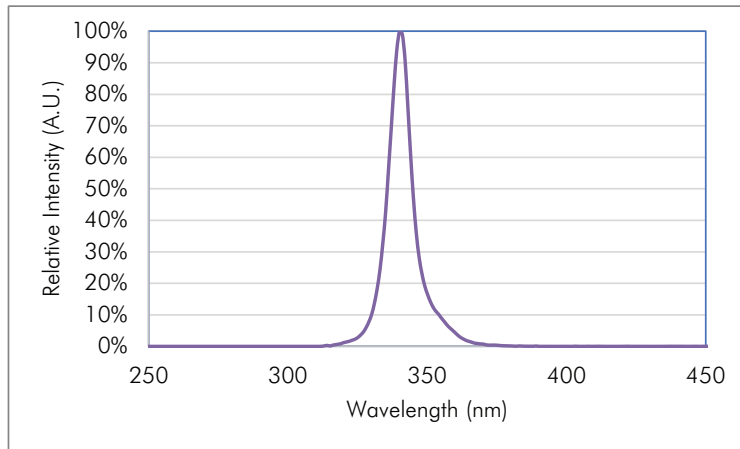

## Forward Current vs. Relative Radiant Flux

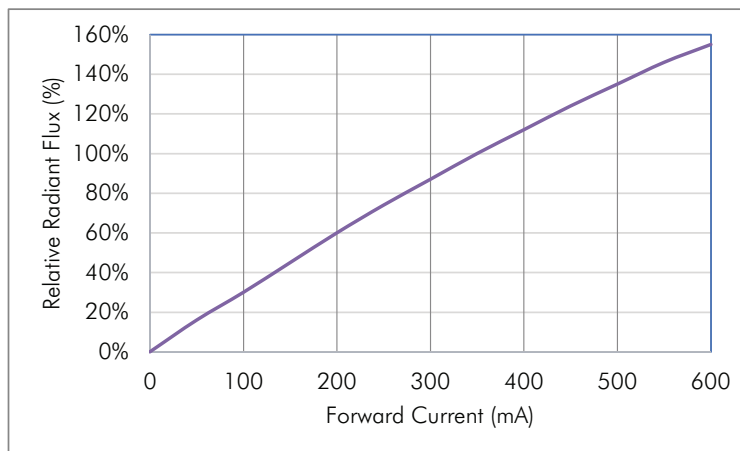

## Forward Voltage vs. Forward Current

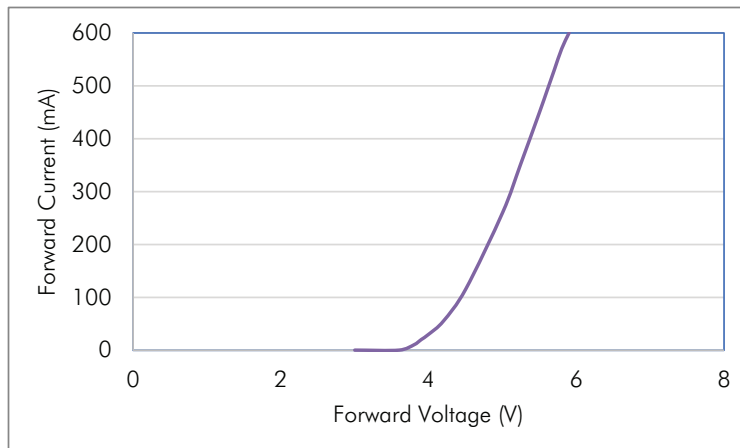

## Handling & Usage Precautions

- Exhibit extreme care when handling LEDs. Do not touch the LED with bare hands as doing so may contaminate and affect the optical characteristics of the LED. When using tweezers, do not apply excessive force, especially to the glass lens. Do not drop the LED as doing so may cause product damage.
- Ensure that electrostatic discharge specifications are followed. Static electricity and surge voltages may cause product damage. Proper electrostatic discharge protection equipment, working machinery, and protected mounting equipment are recommended.
- Do not expose the LEDs to volatile organic compounds as well as hazardous, acidic, and corrosive substances during storage and operation to avoid product damage.
- Do not apply excess mechanical force and vibration while handling the product.
- Do not expose the product to sudden changes in temperature, high humidity levels, and condensation.
- Ensure that the PCB is suitable for the product and be wary of LED placement and possible PCB warpage.
- To avoid fault issues, do not couple any electrical wires to the metal substrate of the MCPCB or COB. If any electrical wires from the power source have contact with the MCPCB's metal base under power ON conditions, permanent damage may occur due to inner arcing within the 3-PAD LED structure.

## Storage Precautions

- Perform soldering as soon as the moisture-proof packaging is opened.
- After the storage duration has exceeded the recommended time, products may need to be baked before soldering.
- Store all products in a controlled environment under 30° C free of dust. Do not expose the product to sudden changes in temperature, high humidity levels, and condensation.
- Please consult the Violumas engineering team for further information on storage precautions.

## Eye Safety Precautions

- Avoid exposure to UV light during LED operation. Do not look directly into the UV light during LED operation. Do not look directly into the UV light during optical measurements even through optical instruments. Protect the body, skin, and eyes with UV protective equipment.
- Attach warning labels on all products and systems that use UV LEDs.

## Cleaning Precautions

- Do not use brushes or organic solvents for cleaning the LEDs.
- Perform electrical and optical measurements before and after cleaning to ensure optimal performance.

## Static Electricity Precautions

- Ensure that equipment and machinery are properly grounded.
- Anti-electrostatic attire (wristbands, gloves, footwear, etc.) is recommended.
- Damage inspection is recommended while performing characteristics inspection of LEDs.

## Disclaimers

Violumas is not responsible for any damages that result from inaccurate use of the recommended guidelines. The information compiled in this document is a result of careful review of reference materials and reliable sources. Violumas does not make any claims regarding warranty or guarantee. It is recommended that each customer consults the Violumas engineering team before engaging Violumas products in extreme applications where the failure of the LED and damage to human health may be possible. Each user assumes full responsibility for determining the suitability of the use of Violumas products in various applications. Disassembling Violumas products without consent is prohibited. No part of these documents may be reproduced in any form without prior written permission from Violumas. Please note that the data presented in this document is measured from the use of exclusive Flip Chip Opto patented products - the 3-PAD LED Flip Chip and the Pillar MCPCB.

## UV LED Application Set

### Plug-and-Play:

- COB UV LED
- Heatsink Kit
- Driver Kit

Violumas COB LED



Violumas Heatsink Kit



Heatsink (x1), Mounting Screws (x2), Thermal Pad (x2)

Violumas Driver Kit with LED Wire & Connector - 110V or 220V



Negative/Black Wire (x1), Positive/Red Wire (x1), 2-Terminal Connectors (x2)

Photos are provided for reference only and may not be accurate of the exact items received.

# UV LED Application Set

## Step 1: Mounting the COB LED onto the Heatsink

- If there is a protective film on the backside of the LED, please remove the film. Inspect the contact surfaces and ensure the contact surfaces of the LED backside and the heatsink are smooth. If surfaces are not smooth, high resolution sandpaper polish is recommended. Gently clean the surfaces with alcohol.
- Place the thermal pad on the coupling area where the LED is to be mounted onto the heatsink.
- Tighten down the LED onto the heatsink surface via provided screws. Do not over torque the screws.

### Violumas LED Wire & Connector Kit:

- Each wire is pre-stripped for plug-and-play connections.
- One end of each wire is stripped approximately 5mm (**short side**). The short side should be inserted into the COB LED.
- One end of each wire is stripped approximately 10mm (**long side**). The long side should be coupled with the driver kit wires.

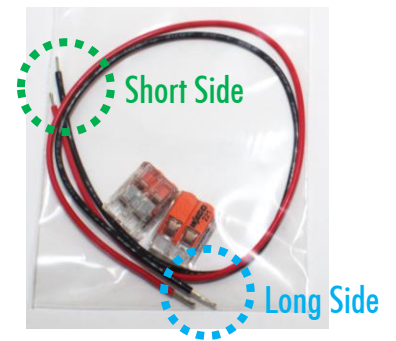

## Step 2: Connecting Wires to the COB LED

- Insert the short side of the "-" wire into the "-" COB connector.
- Insert the short side of the "+" wire into the "+" COB connector.
- Please insert the wire end fully into the appropriate COB connector (positive to positive, negative to negative). The connection should be tight even with a weak pull on the ends of the wires. Soldering is not required.

## Step 3: Connecting Wires to the Driver Kit

- Couple the long side of the "-" wire to the "-" wire of the driver kit using the provided connector.
- Couple the long side of the "+" wire to the "+" wire of the driver kit using the provided connector.
- For coupling wires with the provided connector, please insert the wire end fully into an unoccupied terminal and snap the connector shut. The connection should be tight even with a weak pull on the 2 ends of the wires. Please ensure positive and negative wires are connected appropriately (positive to positive, negative to negative).

## Notes for Operation

- Please ensure the driver kit is off before making any wire connections.
- Please connect the driver kit to a separate power strip (not provided) with an ON/OFF switch. Please utilize the power strip switch to turn the driver kit on and off. Directly plugging the driver kit into a wall outlet is not recommended.
- If the driver kit includes a dimmer dial, please ensure the dimmer dial is set to the lowest position before turning the power on.

# UV LED Application Set

## Disclaimer

Violumas is not responsible for any damages that may result from inaccurate use of the recommended products. Violumas does not make any claims regarding warranty or guarantee of these products. It is recommended that each customer consults the Violumas engineering team before engaging Violumas products in extreme applications where the failure of the LED and damage to human health may be possible. Each user assumes full responsibility for determining the suitability of the use of Violumas products in various applications. Operating Violumas LEDs incorrectly or with an unsuitable driver may result in immediate failure and Violumas will not be responsible for replacement.

## Precautions

### Handling & Usage Precautions

- Exhibit extreme care when handling LEDs. Do not touch the LED with bare hands as doing so may contaminate and affect the optical characteristics of the LED. When using tweezers, do not apply excessive force, especially to the glass lens. Do not drop the LED as doing so may cause product damage.
- Ensure that electrostatic discharge specifications are followed. Static electricity and surge voltages may cause product damage. Proper electrostatic discharge protection equipment, working machinery, and protected mounting equipment are recommended.
- Do not expose the LEDs to volatile organic compounds as well as hazardous, acidic, and corrosive substances during storage and operation to avoid product damage.
- Do not apply excess mechanical force and vibration while handling the product.
- Do not expose the product to sudden changes in temperature, high humidity levels, and condensation.
- Ensure that the PCB is suitable for the product and be wary of LED placement and possible PCB warpage.
- To avoid fault issues, do not couple any electrical wires to the metal substrate of the MCPCB or COB. If any electrical wires from the power source have contact with the MCPCB's metal base under power ON conditions, permanent damage may occur due to inner arcing within the 3-PAD LED structure.

### Storage Precautions

- Perform soldering as soon as the moisture-proof packaging is opened.
- After the storage duration has exceeded the recommended time, products may need to be baked before soldering.
- Store all products in a controlled environment under 30° C free of dust. Do not expose the product to sudden changes in temperature, high humidity levels, and condensation.
- Please consult the Violumas engineering team for further information on storage precautions.

### Eye Safety Precautions

- Avoid exposure to UV light during LED operation. Do not look directly into the UV light during LED operation. Do not look directly into the UV light during optical measurements even through optical instruments. Protect the body, skin, and eyes with UV protective equipment.
- Attach warning labels on all products and systems that use UV LEDs.

### Cleaning Precautions

- Do not use brushes or organic solvents for cleaning the LEDs.
- Perform electrical and optical measurements before and after cleaning to ensure optimal performance.

### Static Electricity Precautions

- Ensure that equipment and machinery are properly grounded.
- Anti-electrostatic attire (wristbands, gloves, footwear, etc.) is recommended.
- Damage inspection is recommended while performing characteristics inspection of LEDs.

**UV LED Application Sets**Purchase on web store: <https://shop.boselec.com/collections/uv-led>

<u>Set Part Number</u>	<u>UV LED</u>	<u>Heat Sink</u>	<u>Driver Kit</u>
<b>265 nm LED</b>			
SET-265-MED-110V	VC1X1C48L3-265	30.1.006770	PS-700A6W-ND-110V
SET-265-MED-220V	VC1X1C48L3-265	30.1.006770	PS-700A6W-ND-220V
SET-265-HI-110V	VC2X2C48L6-265	30.1.006846	PS-1400A25W-ND-110V
SET-265-HI-220V	VC2X2C48L6-265	30.1.006846	request
<b>275 nm LED</b>			
SET-275-MED-110V	VC1X1C48L3-275	30.1.006770	PS-700A6W-ND-110V
SET-275-MED-220V	VC1X1C48L3-275	30.1.006770	PS-700A6W-ND-220V
SET-275-HI-110V	VC2X2C48L6-275	30.1.006846	PS-1400A25W-ND-110V
SET-275-HI-220V	VC2X2C48L6-275	30.1.006846	request
<b>295 nm LED</b>			
SET-295-MED-110V	VC1X1C48L3-295	30.1.006770	PS-700A6W-ND-110V
SET-295-MED-220V	VC1X1C48L3-295	30.1.006770	PS-700A6W-ND-220V
SET-295-HI-110V	VC2X2C48L6-295	30.1.006846	PS-1400A20W-ND-110V
SET-295-HI-220V	VC2X2C48L6-295	30.1.006846	PS-1400A20W-ND-220V
<b>310 nm LED</b>			
SET-310-MED-110V	VC1X1C48L3-310	30.1.006770	PS-700A6W-ND-110V
SET-310-MED-220V	VC1X1C48L3-310	30.1.006770	PS-700A6W-ND-220V
SET-310-HI-110V	VC2X2C48L6-310	30.1.006846	PS-1400A25W-ND-110V
SET-310-HI-220V	VC2X2C48L6-310	30.1.006846	request
<b>325 nm LED</b>			
SET-325-MED-110V	WC1X1C40L3-325	30.1.006770	PS-350A3W-ND
SET-325-MED-220V	WC1X1C40L3-325	30.1.006770	PS-350A3W-ND
<b>340 nm LED</b>			
SET-325-MED-110V	WC1X1C40L3-340	30.1.006770	PS-350A3W-ND
SET-340-MED-220V	WC1X1C40L3-340	30.1.006770	PS-350A3W-ND
<b>365 nm LED</b>			
SET-365-MED-110V	VC1X1C45L6-365	30.1.006770	PS-700A3W-ND
SET-365-MED-220V	VC1X1C45L6-365	30.1.006770	PS-700A3W-ND
SET-365-HI-110V	VC2X2C45L9-365	30.1.006846	PS-1400A16W-ND
SET-365-HI-220V	VC2X2C45L9-365	30.1.006846	request
<b>375 nm LED</b>			
SET-375-MED-110V	VC1X1C45L6-375	30.1.006770	PS-700A3W-ND
SET-375-MED-220V	VC1X1C45L6-375	30.1.006770	PS-700A3W-ND
SET-375-HI-110V	VC2X2C45L9-375	30.1.006846	PS-1400A16W-ND
SET-375-HI-220V	VC2X2C45L9-375	30.1.006846	request
<b>385 nm LED</b>			
SET-385-MED-110V	VC1X1C45L6-385	30.1.006770	PS-700A3W-ND
SET-385-MED-220V	VC1X1C45L6-385	30.1.006770	PS-700A3W-ND
SET-385-HI-110V	VC2X2C45L9-385	30.1.006846	PS-1400A16W-ND
SET-385-HI-220V	VC2X2C45L9-385	30.1.006846	request
<b>395 nm LED</b>			
SET-395-MED-110V	VC1X1C45L6-395	30.1.006770	PS-700A3W-ND
SET-395-MED-220V	VC1X1C45L6-395	30.1.006770	PS-700A3W-ND
SET-395-HI-110V	VC2X2C45L9-395	30.1.006846	PS-1400A16W-ND
SET-395-HI-220V	VC2X2C45L9-395	30.1.006846	request
<b>405 nm LED</b>			
SET-405-MED-110V	VC1X1C45L6-405	30.1.006770	PS-700A3W-ND
SET-405-MED-220V	VC1X1C45L6-405	30.1.006770	PS-700A3W-ND
SET-405-HI-110V	VC2X2C45L9-405	30.1.006846	PS-1400A16W-ND
SET-405-HI-220V	VC2X2C45L9-405	30.1.006846	request