

395nm UVA LED

- **SMD**
 - **medium & high power**
- **Chip on Board (COB)**
- **Light Bars (12x1)**

 **Boston**Electronics

www.boselec.com

uv@boselec.com

shop.boselec.com

617.566.3821

395 UVA LED

Contents

SMD

- medium power - 1280 mW, 60 deg.
- high power - 4700 mW, 90 deg.

COB

- medium power
- high power
- 12 x 1 light bar

Driver Board

- UPS Driver

VS5252C45L6-395 Mid Power UVA LED SMD

VS5252C45L6-395 is a UV LED Surface Mount Device (SMD) offering UV radiation at a peak wavelength of $395 \pm 5\text{nm}$. Each SMD is structured based on the patented 3-PAD LED Flip Chip and unique low temperature bonding technologies to further boost lighting efficiency and decrease the thermal resistance. The VS5252C45L6 series is packaged in a single-chip structure equipped with a 60° lens for mid power UV output.

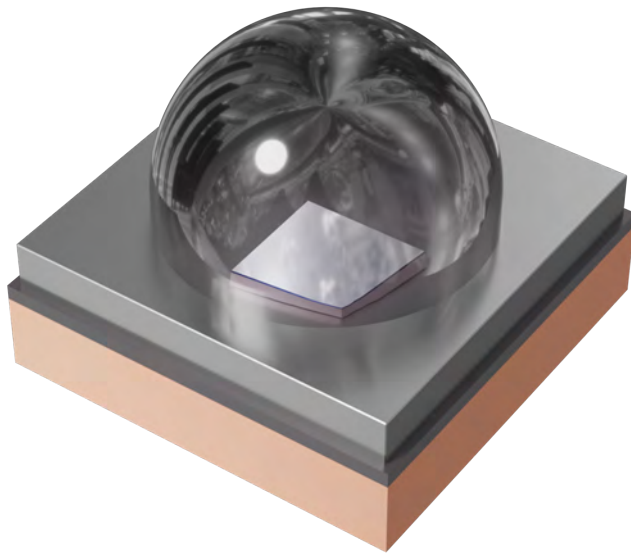

FEATURES & BENEFITS

- Optical output up to 1300mW
- Dimensions: 5.2x5.2mm
- Equipped with 60° fused silica lens
- Ideal for mid power applications

THE VIOLUMAS DIFFERENCE

- 3-PAD flip chip structure
- Lowest thermal resistance at 0.9°C/W
- Minimal thermal decay with higher output
- Industry-leading reliability & lifetime

Electro-Optical Characteristics at T=25°C and I_F = 700mA

Parameter	Symbol	Unit	Min	Typical	Max
Peak Wavelength	λ_p	nm	390	395	400
Forward Voltage	V _F	V	-	3.73	-
Radiant Flux	P _O	mW	1200	1280	1300
Full Width of Half Magnitude	$\Delta\lambda$	nm	-	12	-
Radiant Angle	2 $\Phi_{1/2}$	Degree	-	60	-
Thermal Resistance, Junction to Solder Joint	R _{th(J-S)}	°C/W	-	0.9	-

Absolute Maximum Ratings

Parameter	Symbol	Unit	Value
Forward Current	I _F	mA	1000
Reverse Voltage	V _R	V	5
Power	P _O	W	4
Junction Temperature	T _J	°C	115
Operating Temperature	T _{OPR}	°C	-30 ~ 80
Storage Temperature	T _{STG}	°C	-40 ~ 100

Reliability

Test	Condition	Test Duration	Test Failed/Tested
Operating Temperature	-45°C ~ 125°C	200 Cycles	0/10
Storage Temperature	I _F = 350mA, T = 25°C	1000 Hours	0/10

Mechanical Dimensions

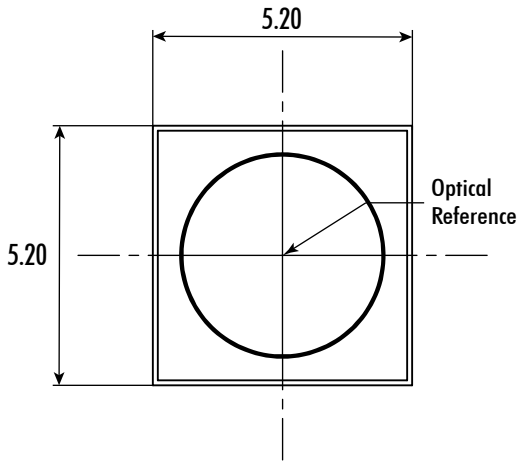

Top View

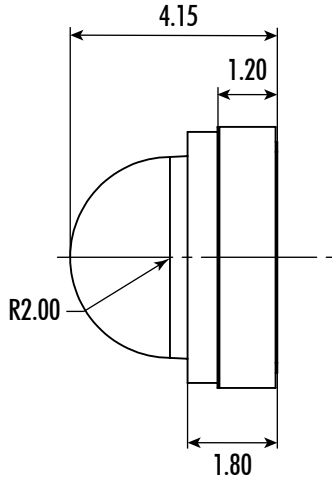

Side View

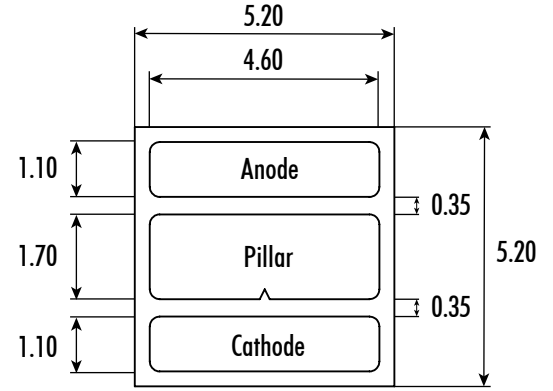

Bottom View

Radiation Pattern

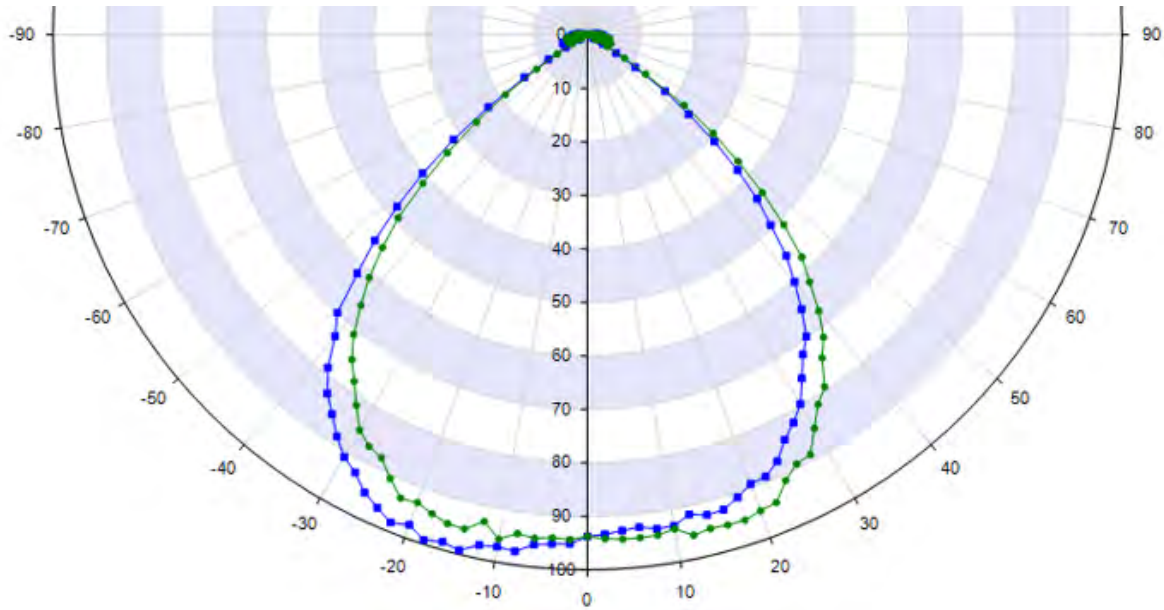

Spectral Output

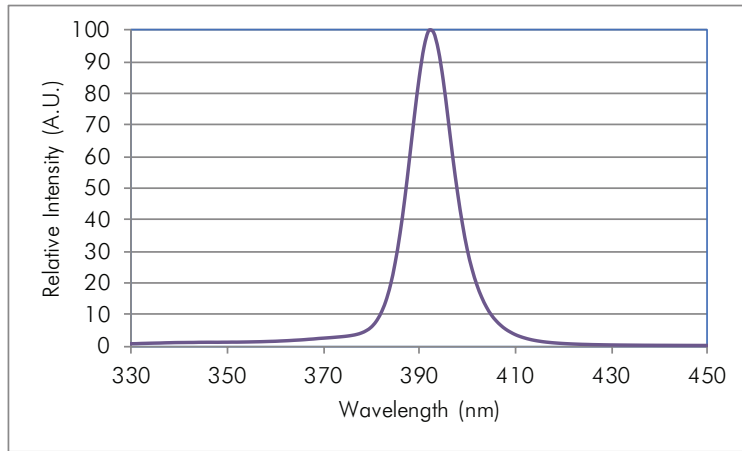

Forward Current vs. Relative Radiant Flux

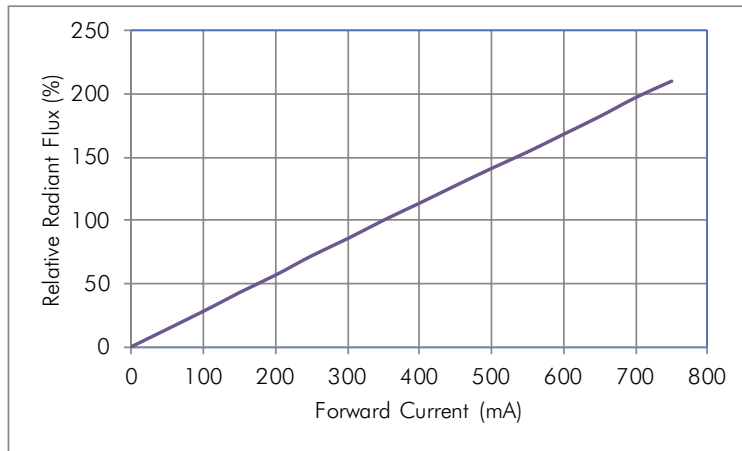

Forward Voltage vs. Forward Current

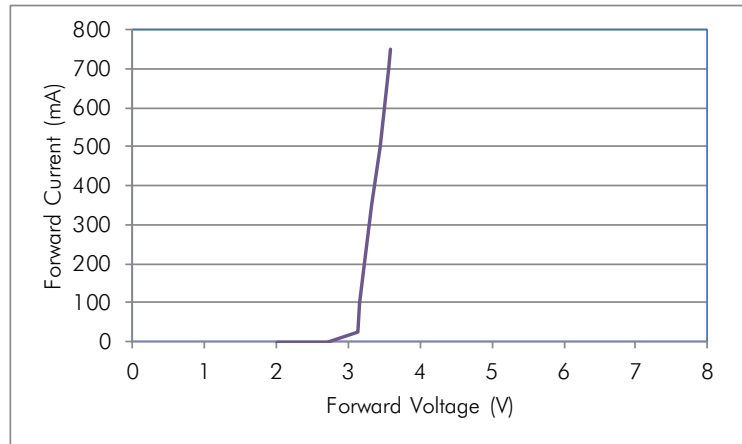

Soldering Guidelines

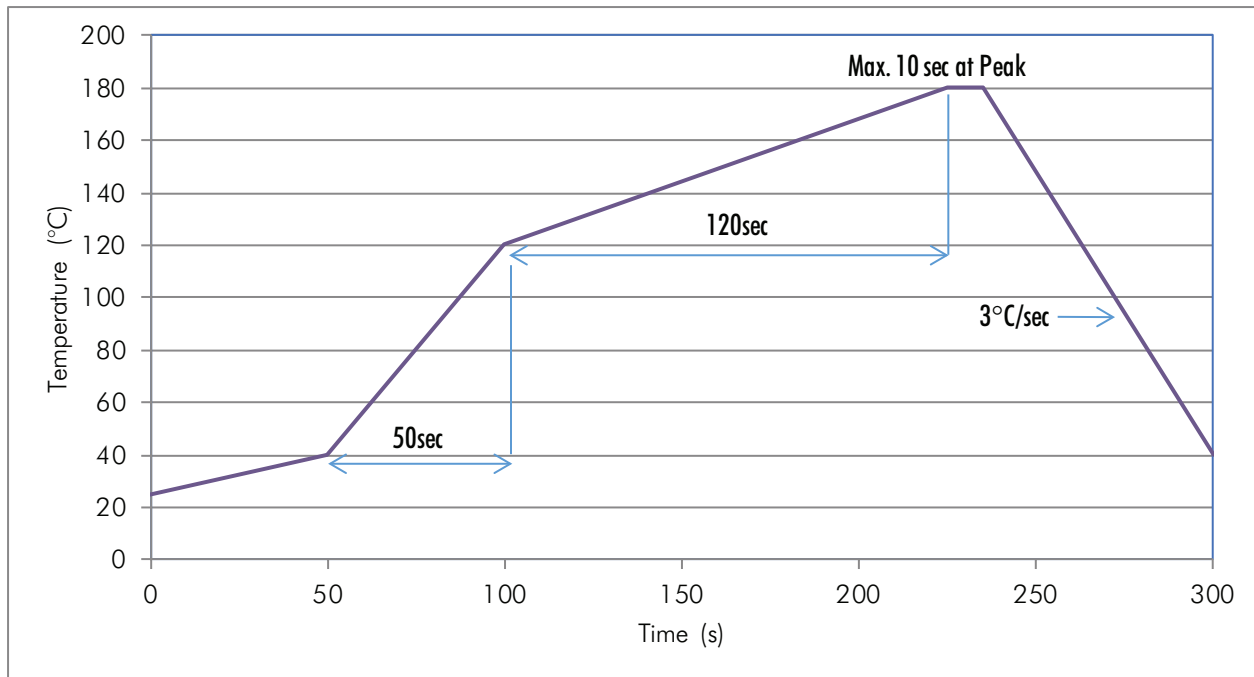

Recommended MCPCB

Violumas recommends the use of the Pillar MCPCB with Violumas LEDs for maximum performance and reliability. The data presented in this document is measured from the use of exclusive Flip Chip Opto patented products - the 3-PAD LED Flip Chip and the Pillar MCPCB. Please consult the Violumas engineering team for further recommendations on MCPCB options.

Handling & Usage Precautions

- Exhibit extreme care when handling LEDs. Do not touch the LED with bare hands as doing so may contaminate and affect the optical characteristics of the LED. When using tweezers, do not apply excessive force, especially to the glass lens. Do not drop the LED as doing so may cause product damage.
- Ensure that electrostatic discharge specifications are followed. Static electricity and surge voltages may cause product damage. Proper electrostatic discharge protection equipment, working machinery, and protected mounting equipment are recommended.
- Do not expose the LEDs to volatile organic compounds as well as hazardous, acidic, and corrosive substances during storage and operation to avoid product damage.
- Do not apply excess mechanical force and vibration while handling the product.
- Do not expose the product to sudden changes in temperature, high humidity levels, and condensation.
- Ensure that the PCB is suitable for the product and be wary of LED placement and possible PCB warpage.

Storage Precautions

- Perform soldering as soon as the moisture-proof packaging is opened.
- After the storage duration has exceeded the recommended time, products may need to be baked before soldering.
- Store all products in a controlled environment under 30° C free of dust. Do not expose the product to sudden changes in temperature, high humidity levels, and condensation.
- Please consult the Violumas engineering team for further information on storage precautions.

Eye Safety Precautions

- Avoid exposure to UV light during LED operation. Do not look directly into the UV light during LED operation. Do not look directly into the UV light during optical measurements even through optical instruments. Protect the body, skin, and eyes with UV protective equipment.
- Attach warning labels on all products and systems that use UV LEDs.

Cleaning Precautions

- Do not use brushes or organic solvents for cleaning the LEDs.
- Perform electrical and optical measurements before and after cleaning to ensure optimal performance.

Static Electricity Precautions

- Ensure that equipment and machinery are properly grounded.
- Anti-electrostatic attire (wristbands, gloves, footwear, etc.) is recommended.
- Damage inspection is recommended while performing characteristics inspection of LEDs.

Disclaimers

Violumas is not responsible for any damages that result from inaccurate use of the recommended guidelines. The information compiled in this document is a result of careful review of reference materials and reliable sources. Violumas does not make any claims regarding warranty or guarantee. It is recommended that each customer consults the Violumas engineering team before engaging Violumas products in extreme applications where the failure of the LED and damage to human health may be possible. Each user assumes full responsibility for determining the suitability of the use of Violumas products in various applications. Disassembling Violumas products without consent is prohibited. No part of these documents may be reproduced in any form without prior written permission from Violumas. Please note that the data presented in this document is measured from the use of exclusive Flip Chip Opto patented products - the 3-PAD LED Flip Chip and the Pillar MCPCB.

VS7272C45L9-395 High Power UVA LED SMD

VS7272C45L9-395 is a UV LED Surface Mount Device (SMD) offering UV radiation at a peak wavelength of $395 \pm 5\text{nm}$. Each SMD is structured based on the patented 3-PAD LED Flip Chip and unique low temperature bonding technologies to further boost lighting efficiency and decrease the thermal resistance. The VS7272C45L9 series is packaged in a single-chip structure equipped with a 90° lens for high power UV output.

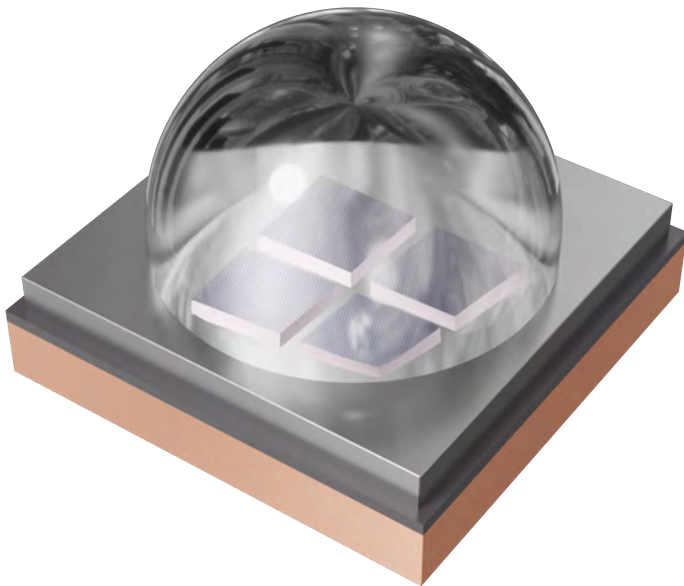

FEATURES & BENEFITS

- Optical output up to 4800mW
- Dimensions: 7.2x7.2mm
- Equipped with 90° fused silica lens
- Ideal for high power applications

THE VIOLUMAS DIFFERENCE

- 3-PAD flip chip structure
- Lowest thermal resistance at 0.2°C/W
- Minimal thermal decay with higher output
- Industry-leading reliability & lifetime

Electro-Optical Characteristics at T=25°C and I_F = 1400mA

Parameter	Symbol	Unit	Min	Typical	Max
Peak Wavelength	λ_p	nm	390	395	400
Forward Voltage	V _F	V	-	7.46	-
Radiant Flux	P _O	mW	4600	4700	4800
Full Width of Half Magnitude	$\Delta\lambda$	nm	-	12	-
Radiant Angle	2 $\Phi_{1/2}$	Degree	-	90	-
Thermal Resistance, Junction to Solder Joint	R _{th(J-S)}	°C/W	-	0.2	-

Absolute Maximum Ratings

Parameter	Symbol	Unit	Value
Forward Current	I _F	mA	2000
Reverse Voltage	V _R	V	10
Power	P _O	W	16
Junction Temperature	T _J	°C	115
Operating Temperature	T _{OPR}	°C	-30 ~ 80
Storage Temperature	T _{STG}	°C	-40 ~ 100

Reliability

Test	Condition	Test Duration	Test Failed/Tested
Operating Temperature	-45°C ~ 125°C	200 Cycles	0/10
Storage Temperature	I _F = 350mA, T = 25°C	1000 Hours	0/10

Mechanical Dimensions

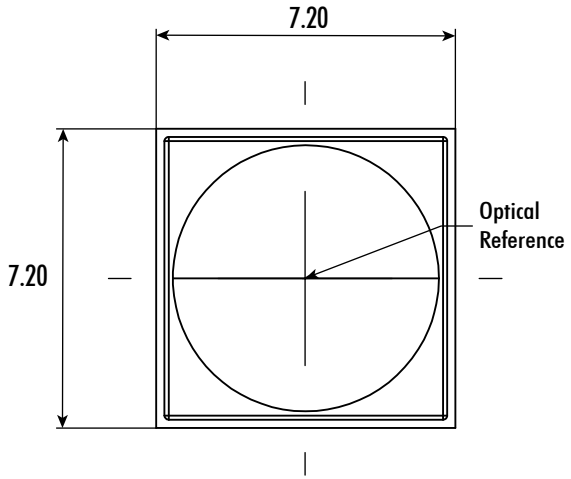

Top View

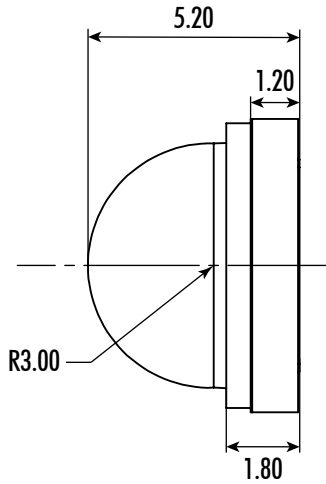

Side View

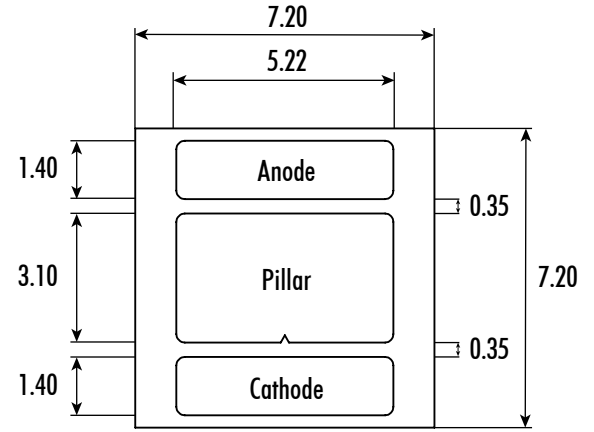

Bottom View

Radiation Pattern

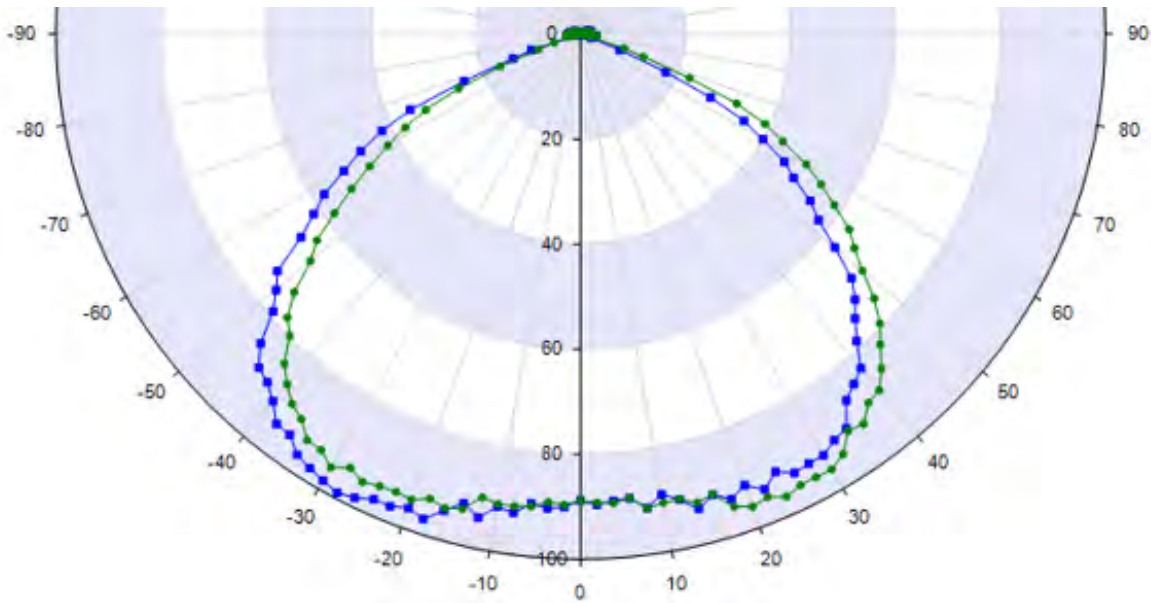

Spectral Output

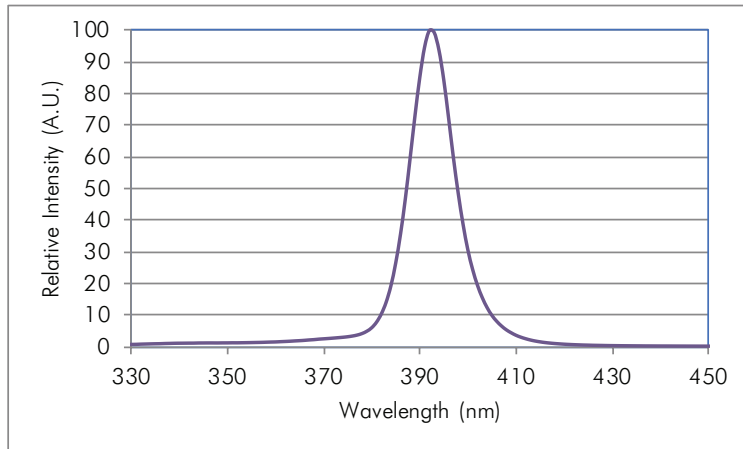

Forward Current vs. Relative Radiant Flux

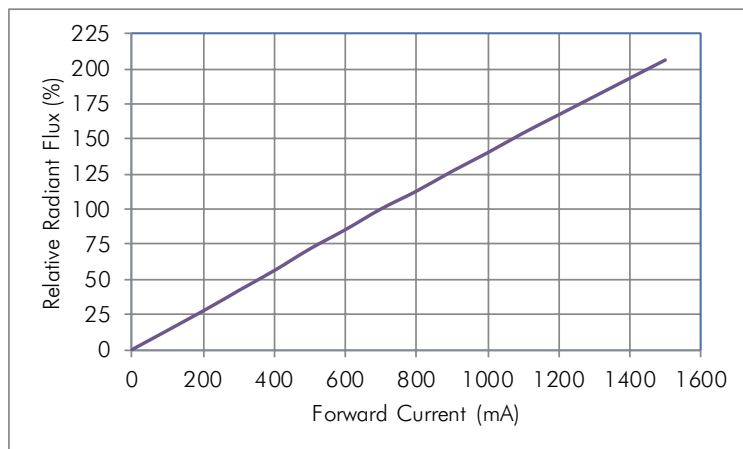

Forward Voltage vs. Forward Current

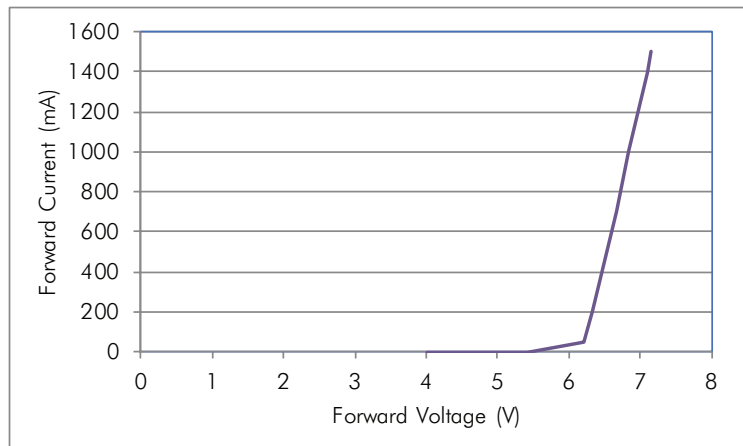

Soldering Guidelines

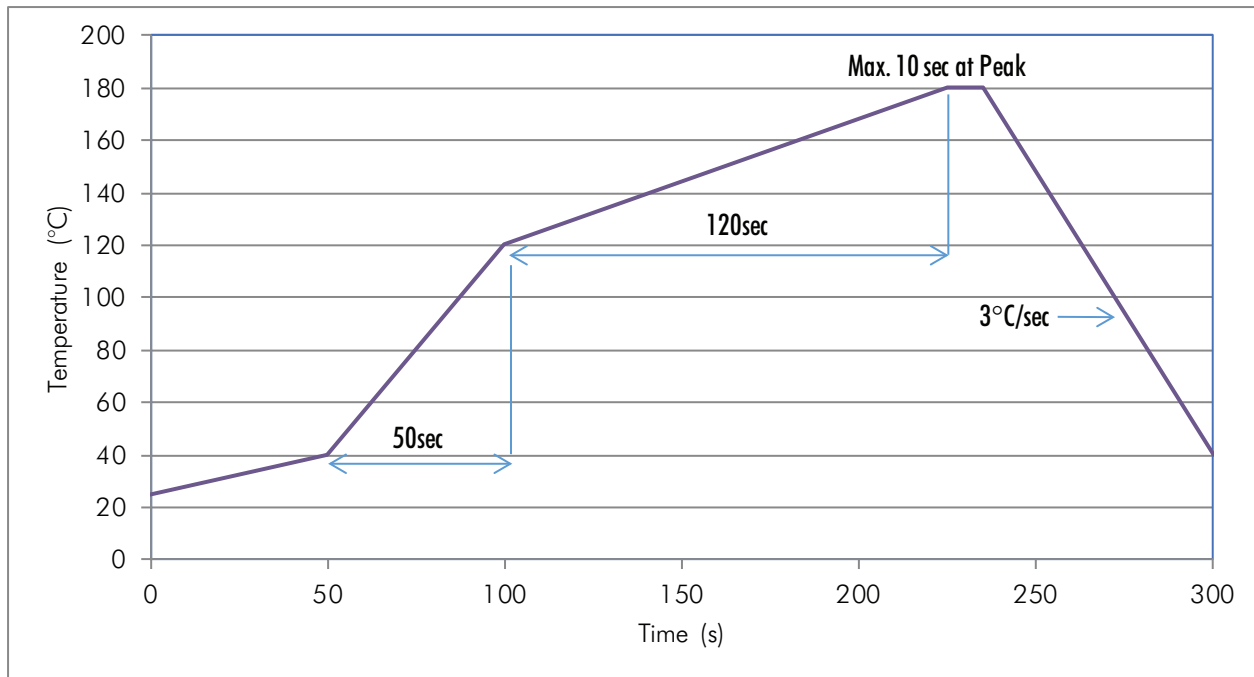

Recommended MCPCB

Violumas recommends the use of the Pillar MCPCB with Violumas LEDs for maximum performance and reliability. The data presented in this document is measured from the use of exclusive Flip Chip Opto patented products - the 3-PAD LED Flip Chip and the Pillar MCPCB. Please consult the Violumas engineering team for further recommendations on MCPCB options.

Handling & Usage Precautions

- Exhibit extreme care when handling LEDs. Do not touch the LED with bare hands as doing so may contaminate and affect the optical characteristics of the LED. When using tweezers, do not apply excessive force, especially to the glass lens. Do not drop the LED as doing so may cause product damage.
- Ensure that electrostatic discharge specifications are followed. Static electricity and surge voltages may cause product damage. Proper electrostatic discharge protection equipment, working machinery, and protected mounting equipment are recommended.
- Do not expose the LEDs to volatile organic compounds as well as hazardous, acidic, and corrosive substances during storage and operation to avoid product damage.
- Do not apply excess mechanical force and vibration while handling the product.
- Do not expose the product to sudden changes in temperature, high humidity levels, and condensation.
- Ensure that the PCB is suitable for the product and be wary of LED placement and possible PCB warpage.

Storage Precautions

- Perform soldering as soon as the moisture-proof packaging is opened.
- After the storage duration has exceeded the recommended time, products may need to be baked before soldering.
- Store all products in a controlled environment under 30° C free of dust. Do not expose the product to sudden changes in temperature, high humidity levels, and condensation.
- Please consult the Violumas engineering team for further information on storage precautions.

Eye Safety Precautions

- Avoid exposure to UV light during LED operation. Do not look directly into the UV light during LED operation. Do not look directly into the UV light during optical measurements even through optical instruments. Protect the body, skin, and eyes with UV protective equipment.
- Attach warning labels on all products and systems that use UV LEDs.

Cleaning Precautions

- Do not use brushes or organic solvents for cleaning the LEDs.
- Perform electrical and optical measurements before and after cleaning to ensure optimal performance.

Static Electricity Precautions

- Ensure that equipment and machinery are properly grounded.
- Anti-electrostatic attire (wristbands, gloves, footwear, etc.) is recommended.
- Damage inspection is recommended while performing characteristics inspection of LEDs.

Disclaimers

Violumas is not responsible for any damages that result from inaccurate use of the recommended guidelines. The information compiled in this document is a result of careful review of reference materials and reliable sources. Violumas does not make any claims regarding warranty or guarantee. It is recommended that each customer consults the Violumas engineering team before engaging Violumas products in extreme applications where the failure of the LED and damage to human health may be possible. Each user assumes full responsibility for determining the suitability of the use of Violumas products in various applications. Disassembling Violumas products without consent is prohibited. No part of these documents may be reproduced in any form without prior written permission from Violumas. Please note that the data presented in this document is measured from the use of exclusive Flip Chip Opto patented products - the 3-PAD LED Flip Chip and the Pillar MCPCB.

VC1X1C45L6-395 Mid Power UVA LED COB

VC1X1C45L6-395 is a UV LED Chip on Board (COB) module offering UV radiation at a peak wavelength of $395\pm 5\text{nm}$. Each COB is structured based on the patented 3-PAD LED Flip Chip mounted directly onto the Super Pillar MCPCB to further boost output efficiency and decrease the thermal resistance. The VC1X1C45L6 series is ready for plug and play with no soldering required and is equipped with a 60° lens for mid power UV output.



FEATURES & BENEFITS

- Dimensions: 15x15x3.0mm
- Ready for plug and play (solder-free)
- Equipped with 60° fused silica lens
- TVS built in for ESD protection

THE VIOLUMAS DIFFERENCE

- 3-PAD flip chip structure
- Lowest thermal resistance at 0.9°C/W
- Minimal thermal decay with higher output
- Industry-leading reliability & lifetime

Electro-Optical Characteristics at T=25°C and I_F = 700mA

Parameter	Symbol	Unit	Min	Typical	Max
Peak Wavelength	λ_p	nm	390	395	400
Forward Voltage	V _F	V	-	3.7	-
Radiant Flux	P _O	mW	1200	1280	1300
Full Width of Half Magnitude	$\Delta\lambda$	nm	-	12	-
Radiant Angle	2 $\Phi_{1/2}$	Degree	-	60	-
Thermal Resistance, Junction to Solder Joint	R _{th(J-S)}	°C/W	-	0.9	-

Absolute Maximum Ratings

Parameter	Symbol	Unit	Value
Forward Current	I _F	mA	1000
Reverse Voltage	V _R	V	5
Power	P _O	W	4
Junction Temperature	T _J	°C	115
Operating Temperature	T _{OPR}	°C	-30 ~ 80
Storage Temperature	T _{STG}	°C	-40 ~ 100

Reliability

Test	Condition	Test Duration	Test Failed/Tested
Operating Temperature	-45°C ~ 125°C	200 Cycles	0/10
Storage Temperature	I _F = 350mA, T = 25°C	1000 Hours	0/10

Product Overview

COB modules are ready for plug and play with no soldering required. All Violumas COBs are equipped with connectors for direct wiring and TVS protection against ESD and voltage issues.

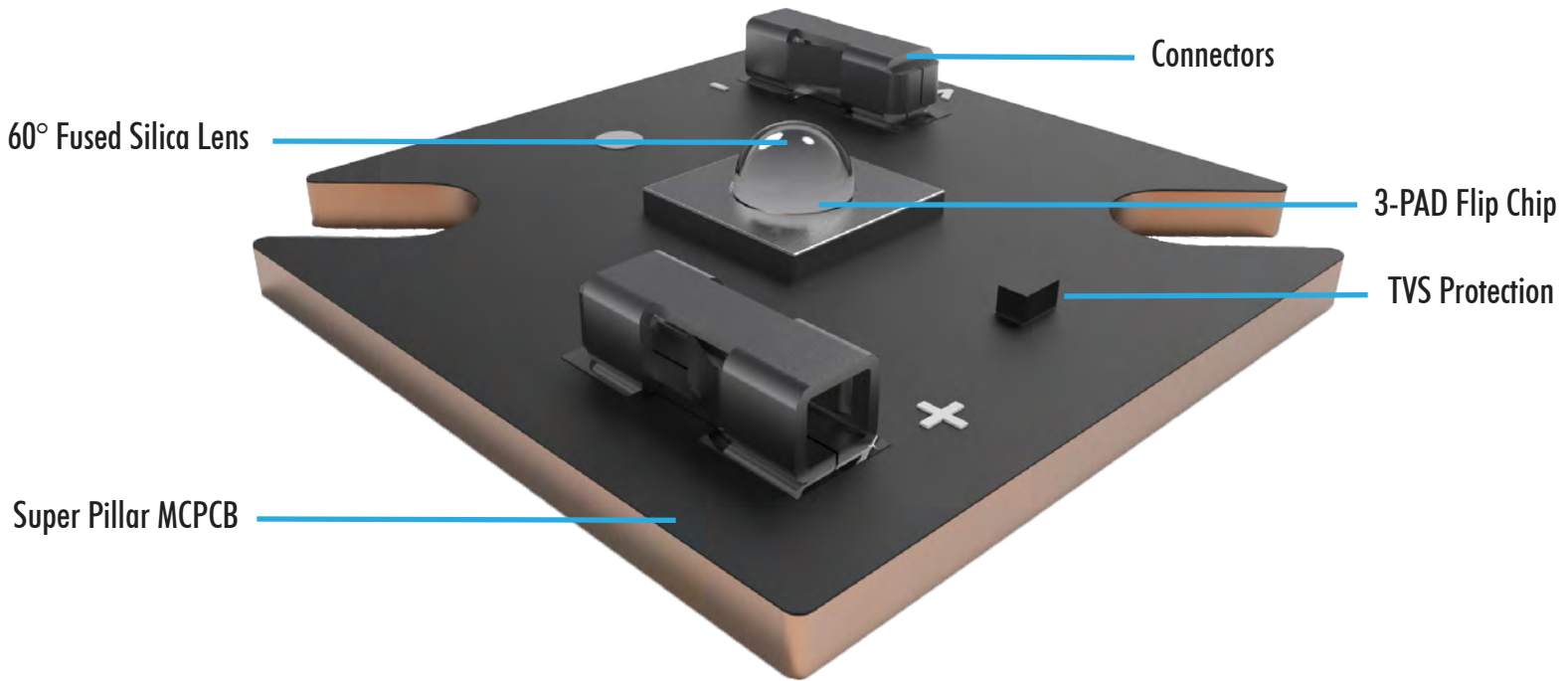

Radiation Pattern

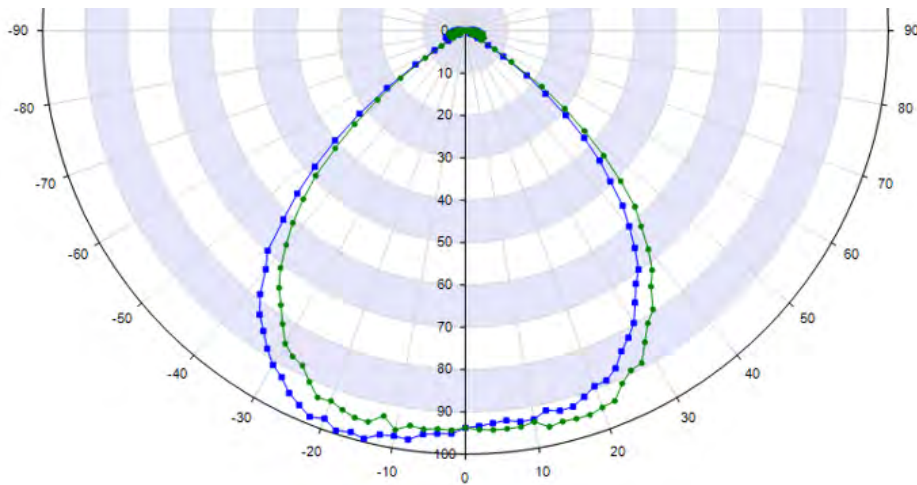

Spectral Output

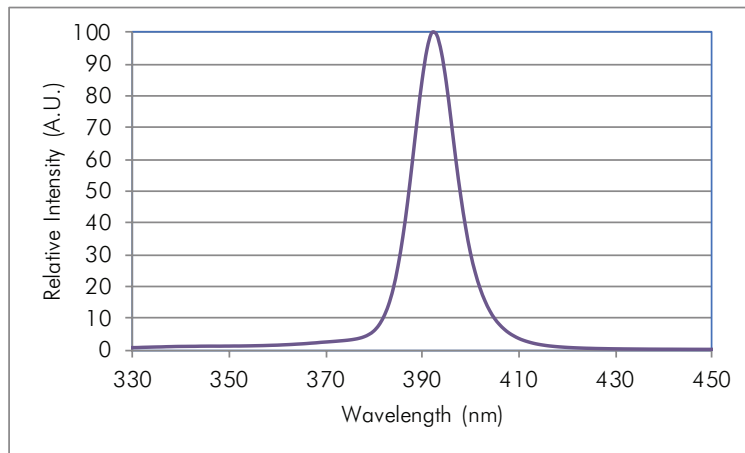

Forward Current vs. Relative Radiant Flux

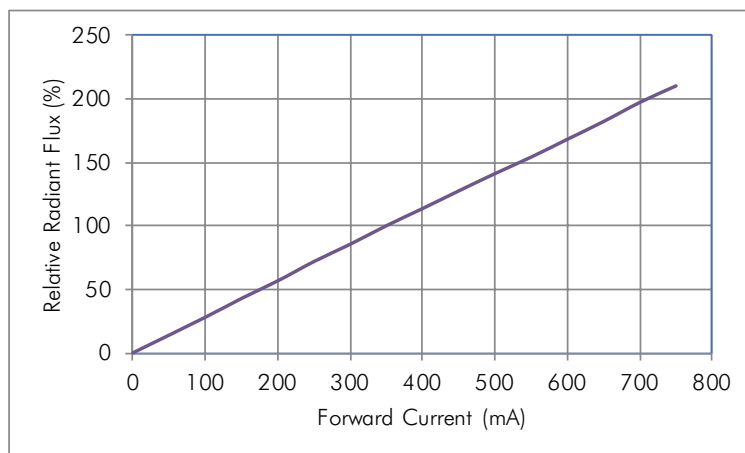

Forward Voltage vs. Forward Current

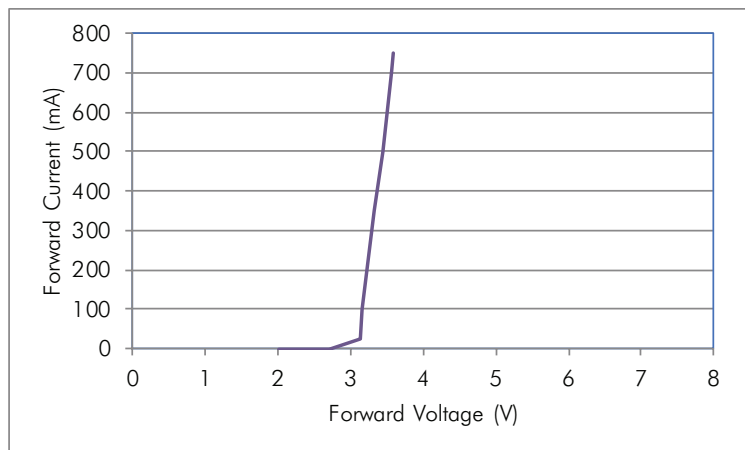

Handling & Usage Precautions

- Exhibit extreme care when handling LEDs. Do not touch the LED with bare hands as doing so may contaminate and affect the optical characteristics of the LED. When using tweezers, do not apply excessive force, especially to the glass lens. Do not drop the LED as doing so may cause product damage.
- Ensure that electrostatic discharge specifications are followed. Static electricity and surge voltages may cause product damage. Proper electrostatic discharge protection equipment, working machinery, and protected mounting equipment are recommended.
- Do not expose the LEDs to volatile organic compounds as well as hazardous, acidic, and corrosive substances during storage and operation to avoid product damage.
- Do not apply excess mechanical force and vibration while handling the product.
- Do not expose the product to sudden changes in temperature, high humidity levels, and condensation.
- Ensure that the PCB is suitable for the product and be wary of LED placement and possible PCB warpage.

Storage Precautions

- Perform soldering as soon as the moisture-proof packaging is opened.
- After the storage duration has exceeded the recommended time, products may need to be baked before soldering.
- Store all products in a controlled environment under 30° C free of dust. Do not expose the product to sudden changes in temperature, high humidity levels, and condensation.
- Please consult the Violumas engineering team for further information on storage precautions.

Eye Safety Precautions

- Avoid exposure to UV light during LED operation. Do not look directly into the UV light during LED operation. Do not look directly into the UV light during optical measurements even through optical instruments. Protect the body, skin, and eyes with UV protective equipment.
- Attach warning labels on all products and systems that use UV LEDs.

Cleaning Precautions

- Do not use brushes or organic solvents for cleaning the LEDs.
- Perform electrical and optical measurements before and after cleaning to ensure optimal performance.

Static Electricity Precautions

- Ensure that equipment and machinery are properly grounded.
- Anti-electrostatic attire (wristbands, gloves, footwear, etc.) is recommended.
- Damage inspection is recommended while performing characteristics inspection of LEDs.

Disclaimers

Violumas is not responsible for any damages that result from inaccurate use of the recommended guidelines. The information compiled in this document is a result of careful review of reference materials and reliable sources. Violumas does not make any claims regarding warranty or guarantee. It is recommended that each customer consults the Violumas engineering team before engaging Violumas products in extreme applications where the failure of the LED and damage to human health may be possible. Each user assumes full responsibility for determining the suitability of the use of Violumas products in various applications. Disassembling Violumas products without consent is prohibited. No part of these documents may be reproduced in any form without prior written permission from Violumas. Please note that the data presented in this document is measured from the use of exclusive Flip Chip Opto patented products - the 3-PAD LED Flip Chip and the Pillar MCPCB.

VC2X2C45L9-395 High Power UVA LED COB

VC2X2C45L9-395 is a UV LED Chip on Board (COB) module offering UV radiation at a peak wavelength of $395 \pm 5\text{nm}$. Each COB is structured based on the patented 3-PAD LED Flip Chip mounted directly onto the Super Pillar MCPCB to further boost output efficiency and decrease the thermal resistance. The VC2X2C45L9 series is ready for plug and play with no soldering required and is equipped with a 90° lens for high power UV output.

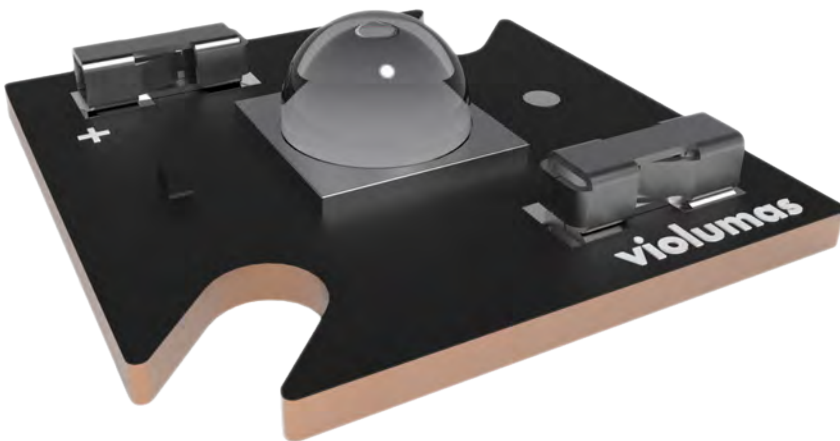

FEATURES & BENEFITS

- Dimensions: 20x20x4.9mm
- Ready for plug and play (solder-free)
- Equipped with 90° fused silica lens
- TVS built in for ESD protection

THE VIOLUMAS DIFFERENCE

- 3-PAD flip chip structure
- Lowest thermal resistance at 0.2°C/W
- Minimal thermal decay with higher output
- Industry-leading reliability & lifetime

Electro-Optical Characteristics at T=25°C and I_F = 1400mA

Parameter	Symbol	Unit	Min	Typical	Max
Peak Wavelength	λ_p	nm	390	395	400
Forward Voltage	V _F	V	-	7.46	-
Radiant Flux	P _O	mW	4600	4700	4800
Full Width of Half Magnitude	$\Delta\lambda$	nm	-	12	-
Radiant Angle	2 $\Phi_{1/2}$	Degree	-	90	-
Thermal Resistance, Junction to Solder Joint	R _{th(J-S)}	°C/W	-	0.2	-

Absolute Maximum Ratings

Parameter	Symbol	Unit	Value
Forward Current	I _F	mA	2000
Reverse Voltage	V _R	V	10
Power	P _O	W	16
Junction Temperature	T _J	°C	115
Operating Temperature	T _{OPR}	°C	-30 ~ 80
Storage Temperature	T _{STG}	°C	-40 ~ 100

Reliability

Test	Condition	Test Duration	Test Failed/Tested
Operating Temperature	-45°C ~ 125°C	200 Cycles	0/10
Storage Temperature	I _F = 350mA, T = 25°C	1000 Hours	0/10

Product Overview

COB modules are ready for plug and play with no soldering required. All Violumas COBs are equipped with connectors for direct wiring and TVS protection against ESD and voltage issues.

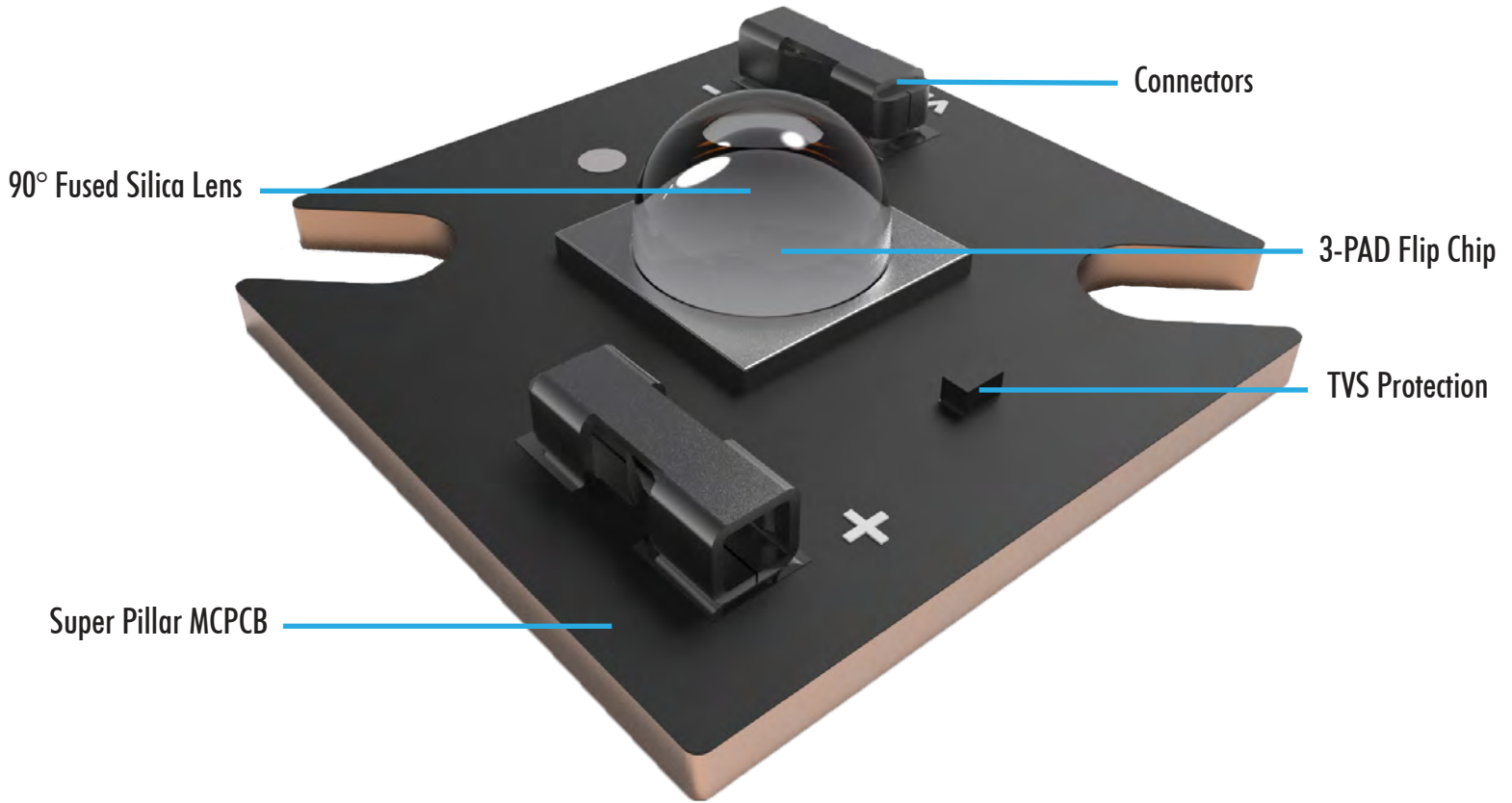

Radiation Pattern

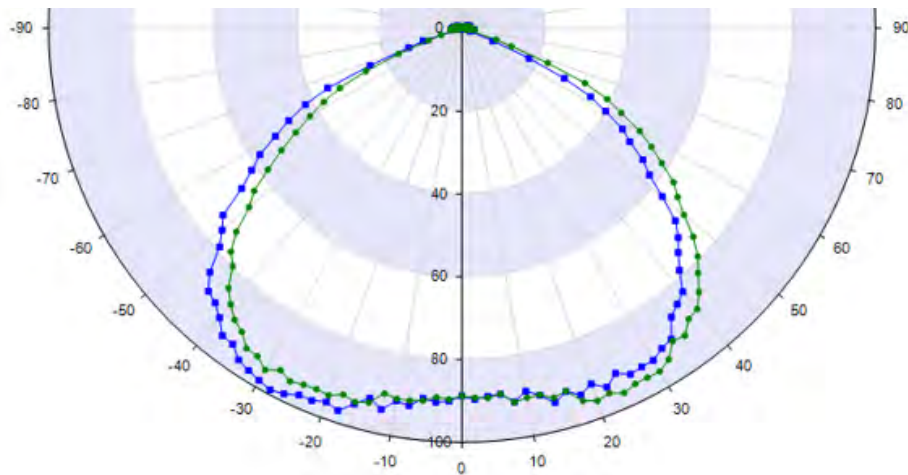

Spectral Output

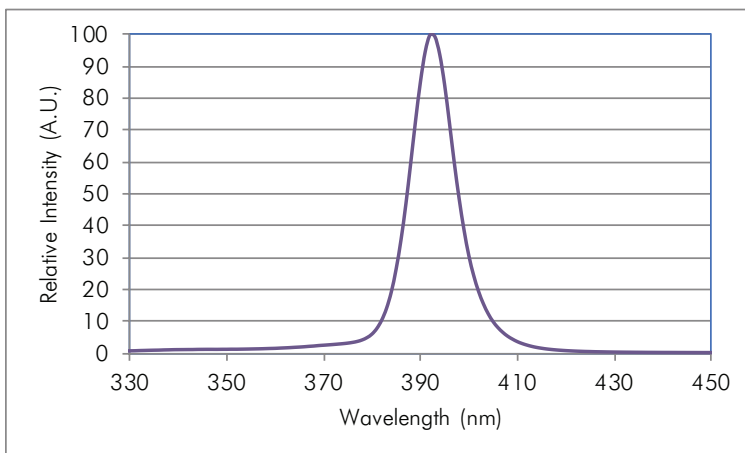

Forward Current vs. Relative Radiant Flux

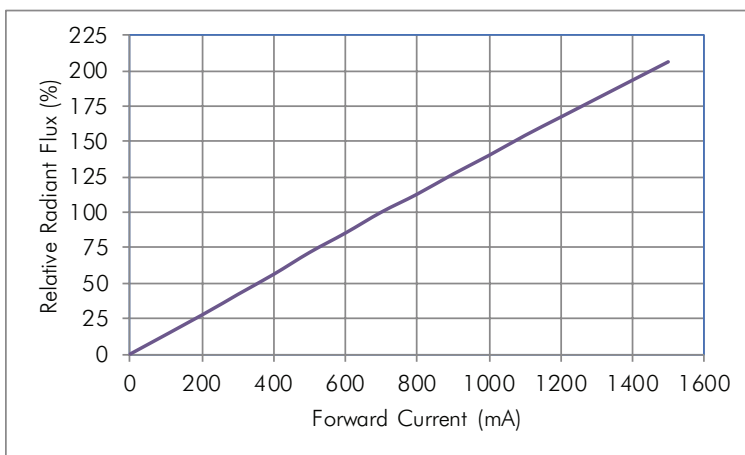

Forward Voltage vs. Forward Current

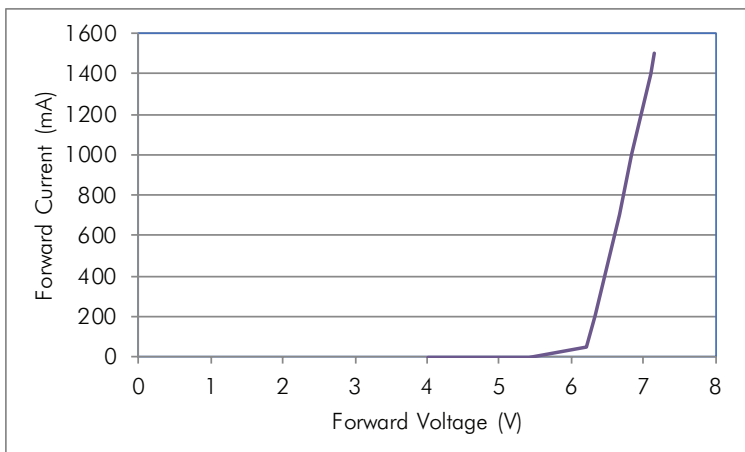

Handling & Usage Precautions

- Exhibit extreme care when handling LEDs. Do not touch the LED with bare hands as doing so may contaminate and affect the optical characteristics of the LED. When using tweezers, do not apply excessive force, especially to the glass lens. Do not drop the LED as doing so may cause product damage.
- Ensure that electrostatic discharge specifications are followed. Static electricity and surge voltages may cause product damage. Proper electrostatic discharge protection equipment, working machinery, and protected mounting equipment are recommended.
- Do not expose the LEDs to volatile organic compounds as well as hazardous, acidic, and corrosive substances during storage and operation to avoid product damage.
- Do not apply excess mechanical force and vibration while handling the product.
- Do not expose the product to sudden changes in temperature, high humidity levels, and condensation.
- Ensure that the PCB is suitable for the product and be wary of LED placement and possible PCB warpage.

Storage Precautions

- Perform soldering as soon as the moisture-proof packaging is opened.
- After the storage duration has exceeded the recommended time, products may need to be baked before soldering.
- Store all products in a controlled environment under 30° C free of dust. Do not expose the product to sudden changes in temperature, high humidity levels, and condensation.
- Please consult the Violumas engineering team for further information on storage precautions.

Eye Safety Precautions

- Avoid exposure to UV light during LED operation. Do not look directly into the UV light during LED operation. Do not look directly into the UV light during optical measurements even through optical instruments. Protect the body, skin, and eyes with UV protective equipment.
- Attach warning labels on all products and systems that use UV LEDs.

Cleaning Precautions

- Do not use brushes or organic solvents for cleaning the LEDs.
- Perform electrical and optical measurements before and after cleaning to ensure optimal performance.

Static Electricity Precautions

- Ensure that equipment and machinery are properly grounded.
- Anti-electrostatic attire (wristbands, gloves, footwear, etc.) is recommended.
- Damage inspection is recommended while performing characteristics inspection of LEDs.

Disclaimers

Violumas is not responsible for any damages that result from inaccurate use of the recommended guidelines. The information compiled in this document is a result of careful review of reference materials and reliable sources. Violumas does not make any claims regarding warranty or guarantee. It is recommended that each customer consults the Violumas engineering team before engaging Violumas products in extreme applications where the failure of the LED and damage to human health may be possible. Each user assumes full responsibility for determining the suitability of the use of Violumas products in various applications. Disassembling Violumas products without consent is prohibited. No part of these documents may be reproduced in any form without prior written permission from Violumas. Please note that the data presented in this document is measured from the use of exclusive Flip Chip Opto patented products - the 3-PAD LED Flip Chip and the Pillar MCPCB.

VC12X1 Series 12-LED Light Bar COB

VC12X1 Series is UV LED Light Bar Chip on Board (COB) module with 12 chips bonded in a linear structure. Each COB is structured based on the patented 3-PAD LED Flip Chip mounted directly onto the Super Pillar MCPCB to further boost output efficiency and decrease the thermal resistance. The VC12X1 Series is ready for plug and play with no soldering required and is equipped with a 60° lens.

FEATURES & BENEFITS

- Dimensions: 304mm x 20mm
- Ready for plug and play (solder-free)
- Equipped with 60° fused silica lens
- TVS built in for ESD protection

THE VIOLUMAS DIFFERENCE

- 3-PAD flip chip structure
- Lowest thermal resistance at 0.075°C/W
- Minimal thermal decay with higher output
- Industry-leading reliability & lifetime

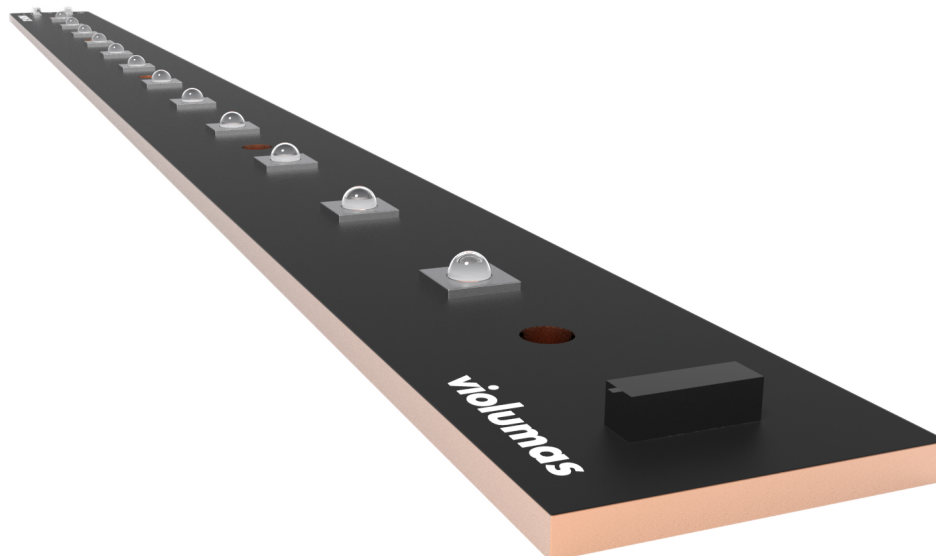

Electro-Optical Characteristics for UVA ($T=25^{\circ}\text{C}$ and $I_F=700\text{mA}$)

Part Number	Wavelength	Typ. Output	Forward Voltage	Power Consumption
VC12X1C45L6-405	405nm	12W	43.5V	30.5W
VC12X1C45L6-395	395nm	13W	43.5V	30.2W
VC12X1C45L6-385	385nm	12W	43.5V	30.2W
VC12X1C45L6-375	375nm	9W	43.5V	30.2W
VC12X1C45L6-365	365nm	6W	46.8V	30.8W

Absolute Maximum Ratings for UVA

Parameter	Symbol	Unit	Value
Forward Current	I_F	mA	1000
Reverse Voltage	V_R	V	60
Power	P_D	W	48
Junction Temperature	T_J	$^{\circ}\text{C}$	120
Operating Temperature	T_{OPR}	$^{\circ}\text{C}$	-30 ~ 85
Storage Temperature	T_{STG}	$^{\circ}\text{C}$	-40 ~ 105

Reliability

Test	Condition	Test Duration	Test Failed/Tested
Thermal Shock	$-45^{\circ}\text{C} \sim 125^{\circ}\text{C}$	2000 Cycles	0/10

Electro-Optical Characteristics for UVB & UVC (T=25°C and I_F = 1400mA)

Part Number	Wavelength	Typ. Output	Forward Voltage	Power Consumption
VC12X1C48L6-310	310nm	1.35W	36.0V	50.4W
VC12X1C48L6-295	295nm	1.1W	36.0V	50.4W
VC12X1C48L6-275	275nm	1W	37.8V	52.9W
VC12X1C48L6-265	265nm	0.8W	38.4V	53.8W

Absolute Maximum Ratings for UVB & UVC

Parameter	Symbol	Unit	Value
Forward Current	I _F	mA	2000
Reverse Voltage	V _R	V	30
Power	P _D	W	84
Junction Temperature	T _J	°C	120
Operating Temperature	T _{OPR}	°C	-30 ~ 85
Storage Temperature	T _{STG}	°C	-40 ~ 105

Reliability

Test	Condition	Test Duration	Test Failed/Tested
Thermal Shock	-45°C ~ 125°C	2000 Cycles	0/10

Product Overview

COB modules are ready for plug and play with no soldering required. All Violumas COBs are equipped with connectors for direct wiring and TVS protection against ESD and voltage issues.

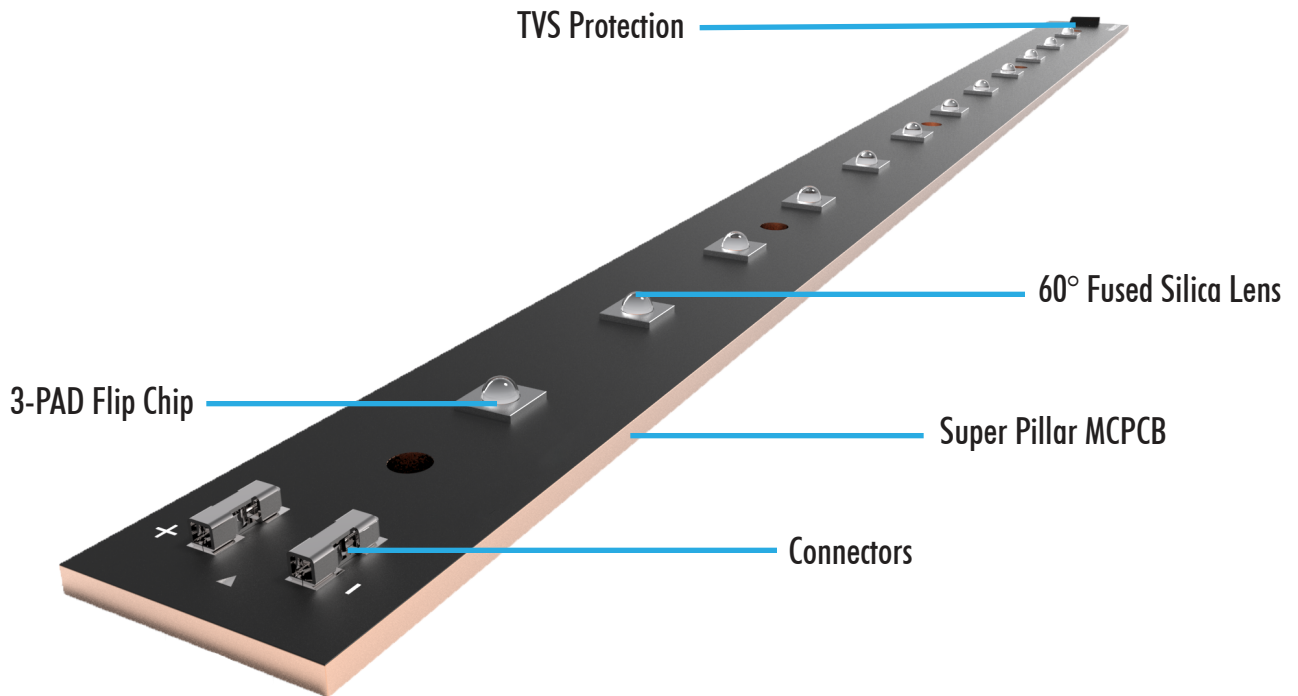

Mechanical Dimensions

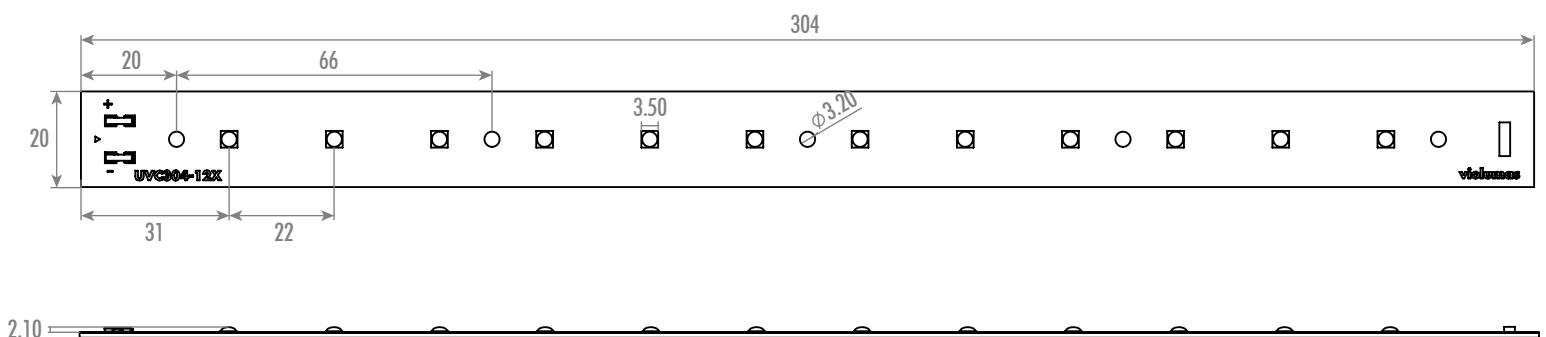

Please contact us for additional information regarding performance curves, irradiance maps, and suitable heatsinks/drivers for this product.

Handling & Usage Precautions

- Exhibit extreme care when handling LEDs. Do not touch the LED with bare hands as doing so may contaminate and affect the optical characteristics of the LED. When using tweezers, do not apply excessive force, especially to the glass lens. Do not drop the LED as doing so may cause product damage.
- Ensure that electrostatic discharge specifications are followed. Static electricity and surge voltages may cause product damage. Proper electrostatic discharge protection equipment, working machinery, and protected mounting equipment are recommended.
- Do not expose the LEDs to volatile organic compounds as well as hazardous, acidic, and corrosive substances during storage and operation to avoid product damage.
- Do not apply excess mechanical force and vibration while handling the product.
- Do not expose the product to sudden changes in temperature, high humidity levels, and condensation.
- Ensure that the PCB is suitable for the product and be wary of LED placement and possible PCB warpage.
- To avoid fault issues, do not couple any electrical wires to the metal substrate of the MCPCB or COB. If any electrical wires from the power source have contact with the MCPCB's metal base under power ON conditions, permanent damage may occur due to inner arcing within the 3-PAD LED structure.

Storage Precautions

- Perform soldering as soon as the moisture-proof packaging is opened.
- After the storage duration has exceeded the recommended time, products may need to be baked before soldering.
- Store all products in a controlled environment under 30° C free of dust. Do not expose the product to sudden changes in temperature, high humidity levels, and condensation.
- Please consult the Violumas engineering team for further information on storage precautions.

Eye Safety Precautions

- Avoid exposure to UV light during LED operation. Do not look directly into the UV light during LED operation. Do not look directly into the UV light during optical measurements even through optical instruments. Protect the body, skin, and eyes with UV protective equipment.
- Attach warning labels on all products and systems that use UV LEDs.

Cleaning Precautions

- Do not use brushes or organic solvents for cleaning the LEDs.
- Perform electrical and optical measurements before and after cleaning to ensure optimal performance.

Static Electricity Precautions

- Ensure that equipment and machinery are properly grounded.
- Anti-electrostatic attire (wristbands, gloves, footwear, etc.) is recommended.
- Damage inspection is recommended while performing characteristics inspection of LEDs.

Disclaimers

Violumas is not responsible for any damages that result from inaccurate use of the recommended guidelines. The information compiled in this document is a result of careful review of reference materials and reliable sources. Violumas does not make any claims regarding warranty or guarantee. It is recommended that each customer consults the Violumas engineering team before engaging Violumas products in extreme applications where the failure of the LED and damage to human health may be possible. Each user assumes full responsibility for determining the suitability of the use of Violumas products in various applications. Disassembling Violumas products without consent is prohibited. No part of these documents may be reproduced in any form without prior written permission from Violumas. Please note that the data presented in this document is measured from the use of exclusive Flip Chip Opto patented products - the 3-PAD LED Flip Chip and the Pillar MCPCB.



Features

- * Easy to use
- * Low cost
- * Simple, flexible control using dedicated software
- * Adjustable voltage to the light source
- * CW or pulsed operation—MHz to DC
- * Nanosecond to seconds repetition rate
- * Current and voltage monitor
- * powered from USB (<0.5A) or DC supply

UPS Driver™

Universal Photon Source (UPS) Driver Board

The Boston Electronics Universal Photon Source (UPS) Driver delivers! It is a flexible, compact, low cost, configurable board, including power supply, that drives a **WIDE** range of light sources. The driver can control pulsed and CW sources, which makes it suitable for driving **ultraviolet (UV), visible and infrared (IR) sources, light emitting diodes (LEDs) and lasers over a frequency range of MHz to DC.**

Control is provided by easy to use PC software. The last used drive parameters are stored in the non-volatile EEPROM memory; thus, the configuration is remembered. The UPS Driver is equipped with voltage and current monitors, trigger output, power and communication inputs and anode/cathode connections for the sources.

The UPS Driver is compatible with UV, visible and IR sources, LEDs and lasers.



UPS Driver Specifications

Developed with, and
manufactured by:



Electrical parameters:

- ◆ Power supply: - USB from computer or +5 ... +6 V, connected to the DC Jack connector
- ◆ Average power delivered to connected source
 - ◇ max. 1.5W, for the power supply from USB
 - ◇ max. 10W, for the power supply connected to the DC Jack connector
- ◆ Adjustable output voltage supply, in the range 0.5 – 25V, 4095 steps
- ◆ Maximum current: 10 A (tested with QCL at 20 V and 100 ns pulse width)
- ◆ Monitor for the supply voltage source (ADC)
- ◆ Master clock period / frequency:
- ◆ main clock period / frequency output signal max. period / min. frequency

25 ns / 20 MHz	1.638 ms / 610 Hz
50 ns / 10 MHz	3.27 ms / 305 Hz
100 ns / 5 MHz	6.55 ms / 152 Hz
200 ns / 2.5 MHz	13.1 ms / 76.3 Hz
1600 ns / 0.312 MHz	104 ms / 9.54 Hz
6.4 μs / 78 kHz	420 ms / 2.38 Hz
25.6 μs / 19.5 kHz	1.677 s / 0.594 Hz
- ◆ Pulse repetition period - adjustable in the range 1 ... 65535 times the period of the master clock
- ◆ Pulse duration - adjustable in the range 1 ... 65535 times the period of the master clock
 - ◇ if pulse duration is higher than the period, source stays on – CW operation
- ◆ Driving signal rise / fall times < 3 ns.
- ◆ Pulse jitter : 6 ns pp
- ◆ Trigger output starts 50 ns before the IR pulse
 - ◇ adjustable duration time in the range 1 ... 65535 times the period of the master clock
- ◆ Power supply monitor
- ◆ Source average current monitor - time constant 100 ms
- ◆ All parameters have their equivalent – minimum/maximum to provide for safe operation
- ◆ Anode of the source is connected to ground, cathode below ground potential

Software

- ◆ The UPS Driver is configured using PC software, or text protocols.

Connections:

- ◆ trigger output—SMA connector
 - ◇ output impedance 50 Ω
 - ◇ standard LVTTTL: logic 0 - 0 V, logic 1 – 3,3 V @ Hi-imp, 1.65 V @ 50 Ω
- ◆ output current monitor—SMA connector
 - ◇ DC offset ~ 100 mV @ 50 Ω
 - ◇ current sensitivity 0.1 V/A @ 50 Ω / can be modified
 - ◇ 100 MHz BW
- ◆ output voltage monitor—SMA connector
 - ◇ DC offset ~ 100 mV @ 50 Ω
 - ◇ voltage sensitivity 50mV/V @ 50 Ω / can be modified
 - ◇ 100 MHz bandwidth
- ◆ micro-USB connector
 - ◇ communication with PC, virtual COM port
 - ◇ power supply, if current consumption of the driver does not exceed 0.5 A (USB 2.0 standard)
- ◆ DC power jack 2.5/5.5
 - ◇ power supply, if driver requires more than 0.5A (USB 2.0 standard), or If the PC is not used (configuration is restored from the memory)

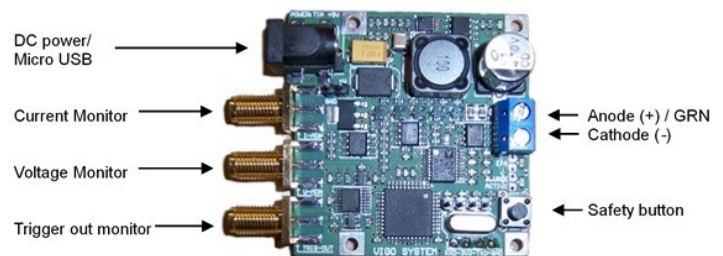
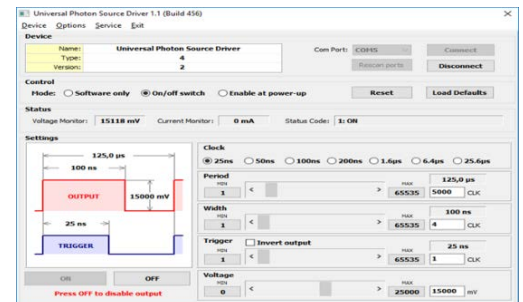

Size:

- ◆ PCB dimensions 60x50x15mm (width×height×depth), including connectors