

Original Generation (V0) UV LEDs 265 nm

- **lower cost/lower power**
- **medium & high power**
- **Surface Mount (SMD)**
- **Chip on Board (COB)**
- **3x3 and 4x4 Arrays - COB**
- **Light Bars (12x1)**

 **Boston**Electronics

www.boselec.com

uv@boselec.com

shop.boselec.com

617.566.3821

265 nm

**Original
Generation**

VS5252C48L3-265 Mid Power UVC LED SMD

VS5252C48L3-265 is a UV LED Surface Mount Device (SMD) offering UV radiation at a peak wavelength of $265 \pm 5\text{nm}$. Each SMD is structured based on the patented 3-PAD LED Flip Chip and unique low temperature bonding technologies to further boost lighting efficiency and decrease the thermal resistance. The VS5252C48L3 series is packaged in a single-chip structure equipped with a 30° lens for mid power UV output.

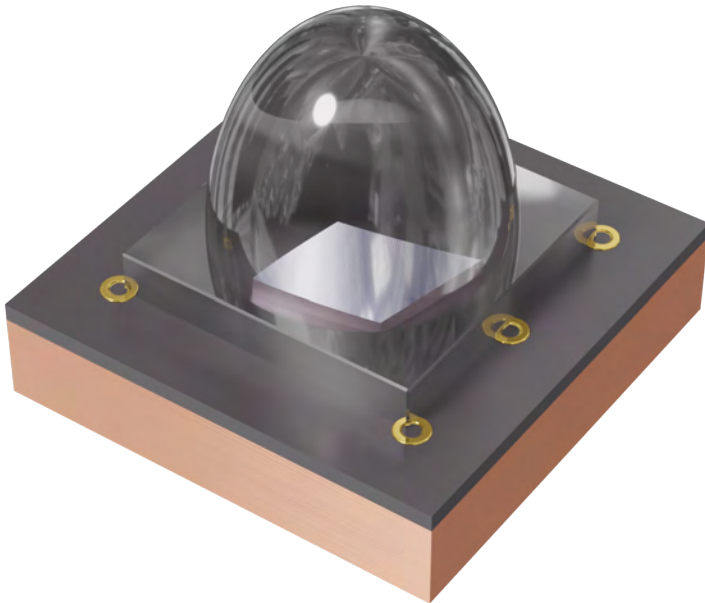

FEATURES & BENEFITS

- Optical output up to 86mW
- Dimensions: 5.2x5.2mm
- Equipped with 30° fused silica lens
- Ideal for mid power applications

THE VIOLUMAS DIFFERENCE

- 3-PAD flip chip structure
- Lowest thermal resistance at 0.9°C/W
- Minimal thermal decay with higher output
- Industry-leading reliability & lifetime

Electro-Optical Characteristics at T=25°C and I_F = 700mA

Parameter	Symbol	Unit	Min	Typical	Max
Peak Wavelength	λ_p	nm	260	265	270
Forward Voltage	V _F	V	-	6.4	-
Radiant Flux	P _O	mW	70	82	86
Full Width of Half Magnitude	$\Delta\lambda$	nm	-	13	-
Radiant Angle	2 $\Phi_{1/2}$	Degree	-	30	-
Thermal Resistance, Junction to Solder Joint	R _{th(J-S)}	°C/W	-	0.9	-

Absolute Maximum Ratings

Parameter	Symbol	Unit	Value
Forward Current	I _F	mA	1000
Reverse Voltage	V _R	V	5
Power	P _O	W	6.5
Junction Temperature	T _J	°C	120
Operating Temperature	T _{OPR}	°C	-30 ~ 85
Storage Temperature	T _{STG}	°C	-40 ~ 100

Reliability

Test	Condition	Test Duration	Test Failed/Tested
Thermal Shock	-45°C ~ 125°C	2000 Cycles	0/10

Mechanical Dimensions

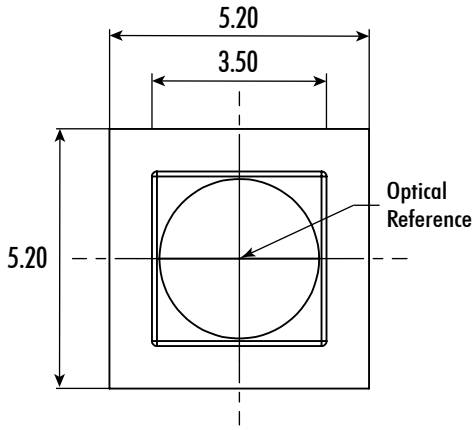

Top View

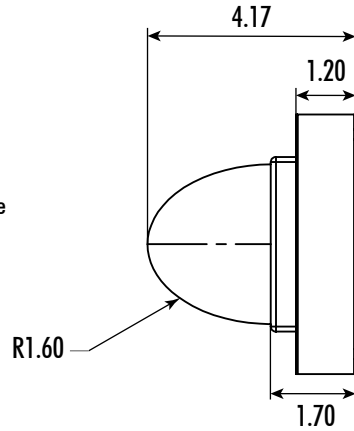

Side View

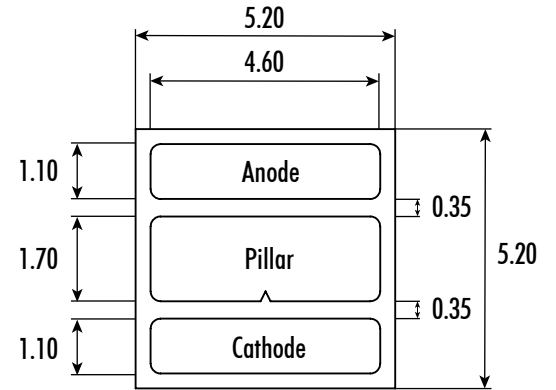

Bottom View

Radiation Pattern

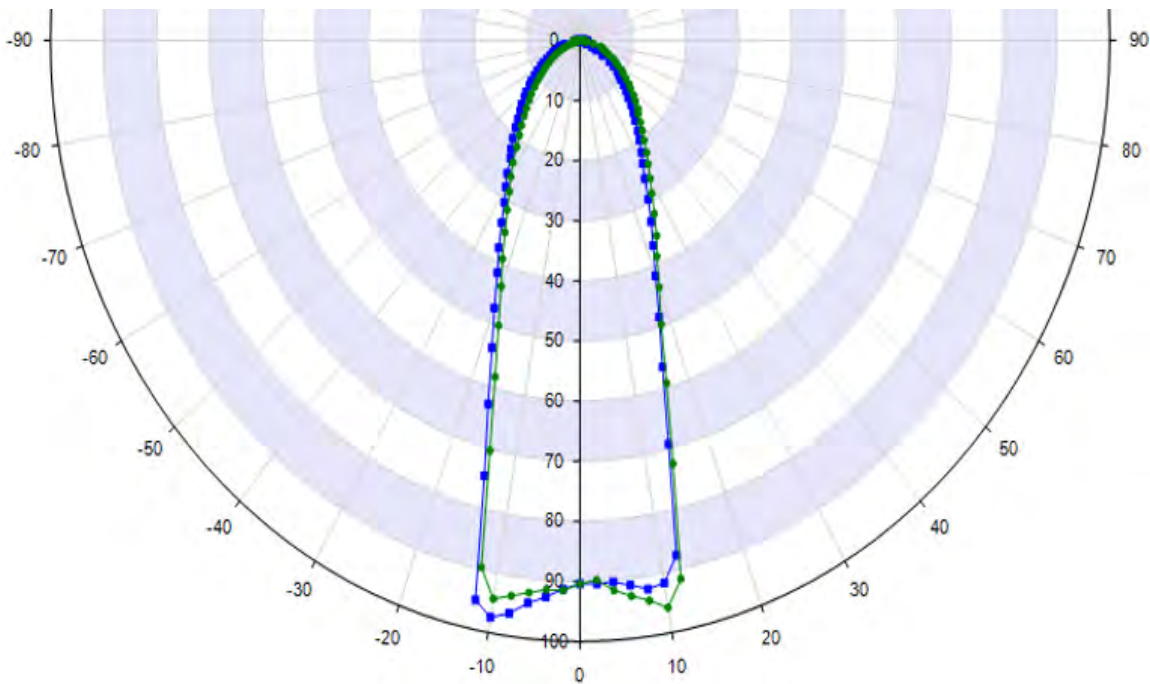

Spectral Output

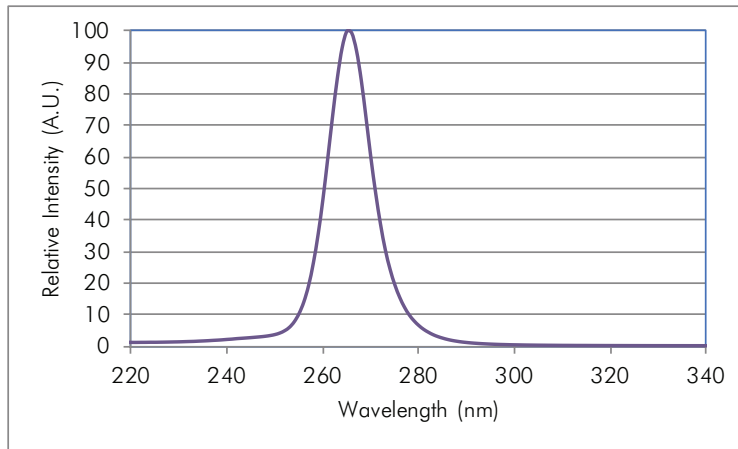

Forward Current vs. Relative Radiant Flux

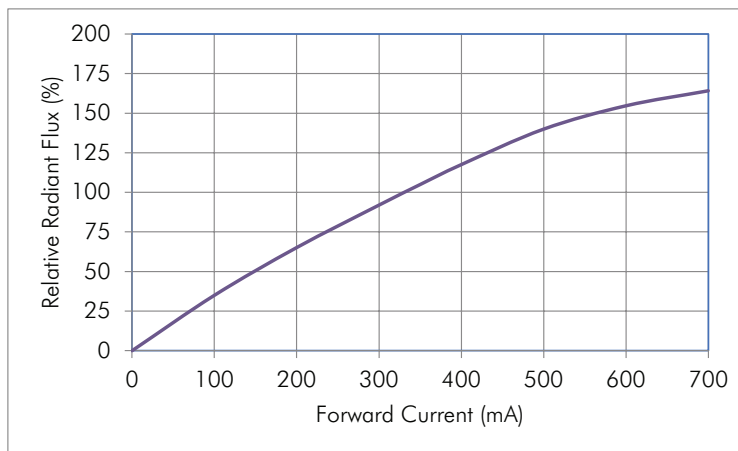

Forward Voltage vs. Forward Current

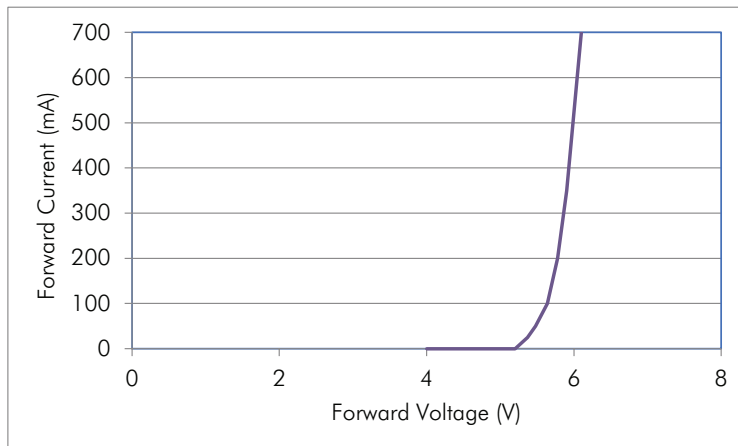

Soldering Guidelines

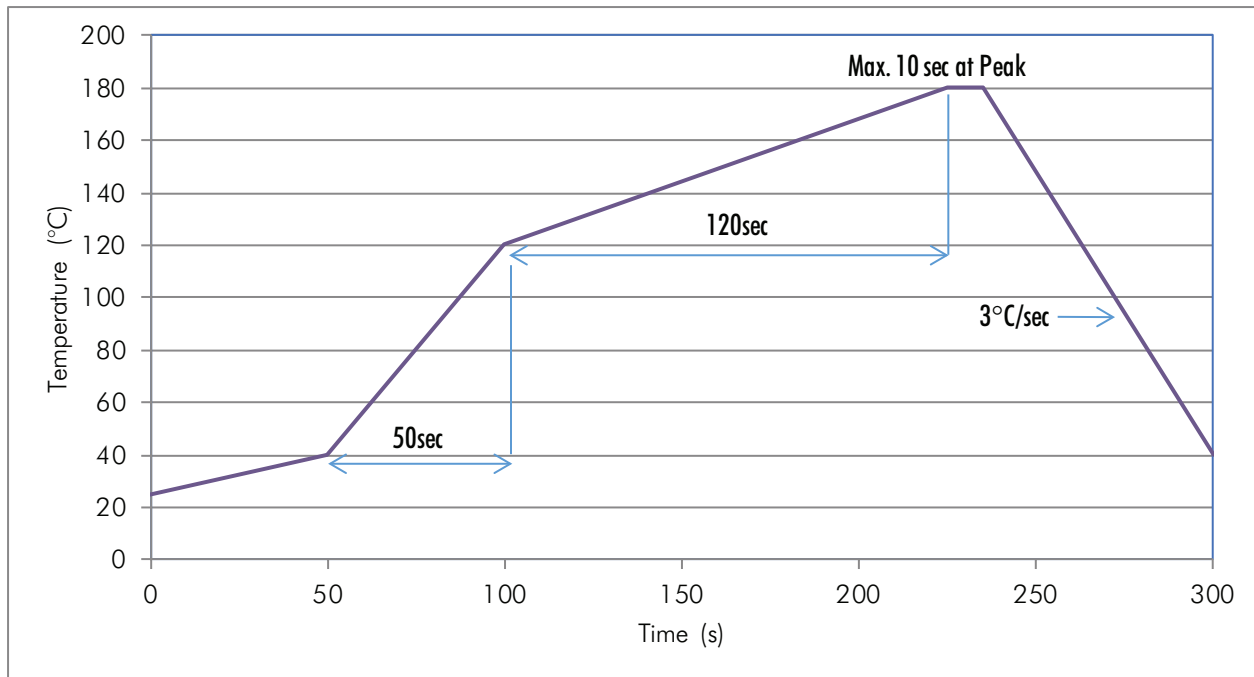

Recommended MCPCB

Violumas recommends the use of the Pillar MCPCB with Violumas LEDs for maximum performance and reliability. The data presented in this document is measured from the use of exclusive Flip Chip Opto patented products - the 3-PAD LED Flip Chip and the Pillar MCPCB. Please consult the Violumas engineering team for further recommendations on MCPCB options.

Handling & Usage Precautions

- Exhibit extreme care when handling LEDs. Do not touch the LED with bare hands as doing so may contaminate and affect the optical characteristics of the LED. When using tweezers, do not apply excessive force, especially to the glass lens. Do not drop the LED as doing so may cause product damage.
- Ensure that electrostatic discharge specifications are followed. Static electricity and surge voltages may cause product damage. Proper electrostatic discharge protection equipment, working machinery, and protected mounting equipment are recommended.
- Do not expose the LEDs to volatile organic compounds as well as hazardous, acidic, and corrosive substances during storage and operation to avoid product damage.
- Do not apply excess mechanical force and vibration while handling the product.
- Do not expose the product to sudden changes in temperature, high humidity levels, and condensation.
- Ensure that the PCB is suitable for the product and be wary of LED placement and possible PCB warpage.
- To avoid fault issues, do not couple any electrical wires to the metal substrate of the MCPCB or COB. If any electrical wires from the power source have contact with the MCPCB's metal base under power ON conditions, permanent damage may occur due to inner arcing within the 3-PAD LED structure.

Storage Precautions

- Perform soldering as soon as the moisture-proof packaging is opened.
- After the storage duration has exceeded the recommended time, products may need to be baked before soldering.
- Store all products in a controlled environment under 30° C free of dust. Do not expose the product to sudden changes in temperature, high humidity levels, and condensation.
- Please consult the Violumas engineering team for further information on storage precautions.

Eye Safety Precautions

- Avoid exposure to UV light during LED operation. Do not look directly into the UV light during LED operation. Do not look directly into the UV light during optical measurements even through optical instruments. Protect the body, skin, and eyes with UV protective equipment.
- Attach warning labels on all products and systems that use UV LEDs.

Cleaning Precautions

- Do not use brushes or organic solvents for cleaning the LEDs.
- Perform electrical and optical measurements before and after cleaning to ensure optimal performance.

Static Electricity Precautions

- Ensure that equipment and machinery are properly grounded.
- Anti-electrostatic attire (wristbands, gloves, footwear, etc.) is recommended.
- Damage inspection is recommended while performing characteristics inspection of LEDs.

Disclaimers

Violumas is not responsible for any damages that result from inaccurate use of the recommended guidelines. The information compiled in this document is a result of careful review of reference materials and reliable sources. Violumas does not make any claims regarding warranty or guarantee. It is recommended that each customer consults the Violumas engineering team before engaging Violumas products in extreme applications where the failure of the LED and damage to human health may be possible. Each user assumes full responsibility for determining the suitability of the use of Violumas products in various applications. Disassembling Violumas products without consent is prohibited. No part of these documents may be reproduced in any form without prior written permission from Violumas. Please note that the data presented in this document is measured from the use of exclusive Flip Chip Opto patented products - the 3-PAD LED Flip Chip and the Pillar MCPCB.

VS7272C48L6-265 High Power UVC LED SMD

VS7272C48L6-265 is a UV LED Surface Mount Device (SMD) offering UV radiation at a peak wavelength of $265 \pm 5\text{nm}$. Each SMD is structured based on the patented 3-PAD LED Flip Chip and unique low temperature bonding technologies to further boost lighting efficiency and decrease the thermal resistance. The VS7272C48L6 series is packaged in a single-chip structure equipped with a 60° lens for high power UV output.

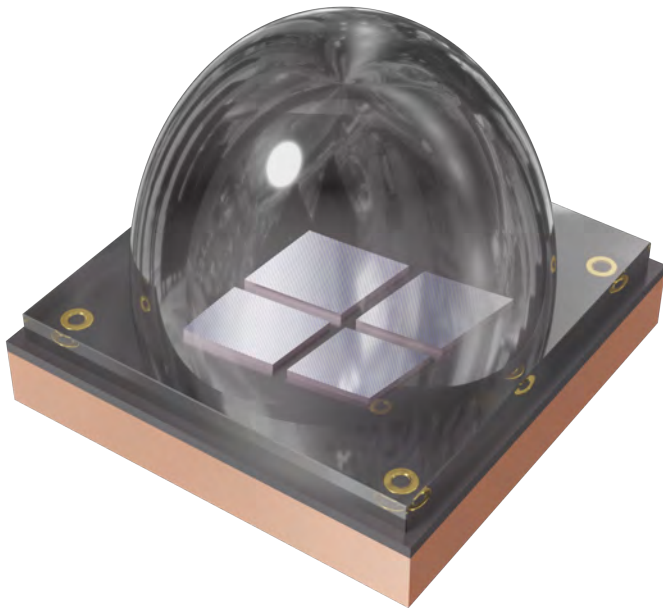

FEATURES & BENEFITS

- Optical output up to 335mW
- Dimensions: 7.2x7.2mm
- Equipped with 60° fused silica lens
- Ideal for high power applications

THE VIOLUMAS DIFFERENCE

- 3-PAD flip chip structure
- Lowest thermal resistance at 0.32°C/W
- Minimal thermal decay with higher output
- Industry-leading reliability & lifetime

Electro-Optical Characteristics at T=25°C and I_F = 1400mA

Parameter	Symbol	Unit	Min	Typical	Max
Peak Wavelength	λ_p	nm	260	265	270
Forward Voltage	V _F	V	-	12.8	-
Radiant Flux	P _O	mW	270	320	335
Full Width of Half Magnitude	$\Delta\lambda$	nm	-	13	-
Radiant Angle	2 $\Phi_{1/2}$	Degree	-	60	-
Thermal Resistance, Junction to Solder Joint	R _{th(J-S)}	°C/W	-	0.32	-

Absolute Maximum Ratings

Parameter	Symbol	Unit	Value
Forward Current	I _F	mA	2000
Reverse Voltage	V _R	V	10
Power	P _O	W	26
Junction Temperature	T _J	°C	120
Operating Temperature	T _{OPR}	°C	-30 ~ 85
Storage Temperature	T _{STG}	°C	-40 ~ 100

Reliability

Test	Condition	Test Duration	Test Failed/Tested
Thermal Shock	-45°C ~ 125°C	2000 Cycles	0/10

Mechanical Dimensions

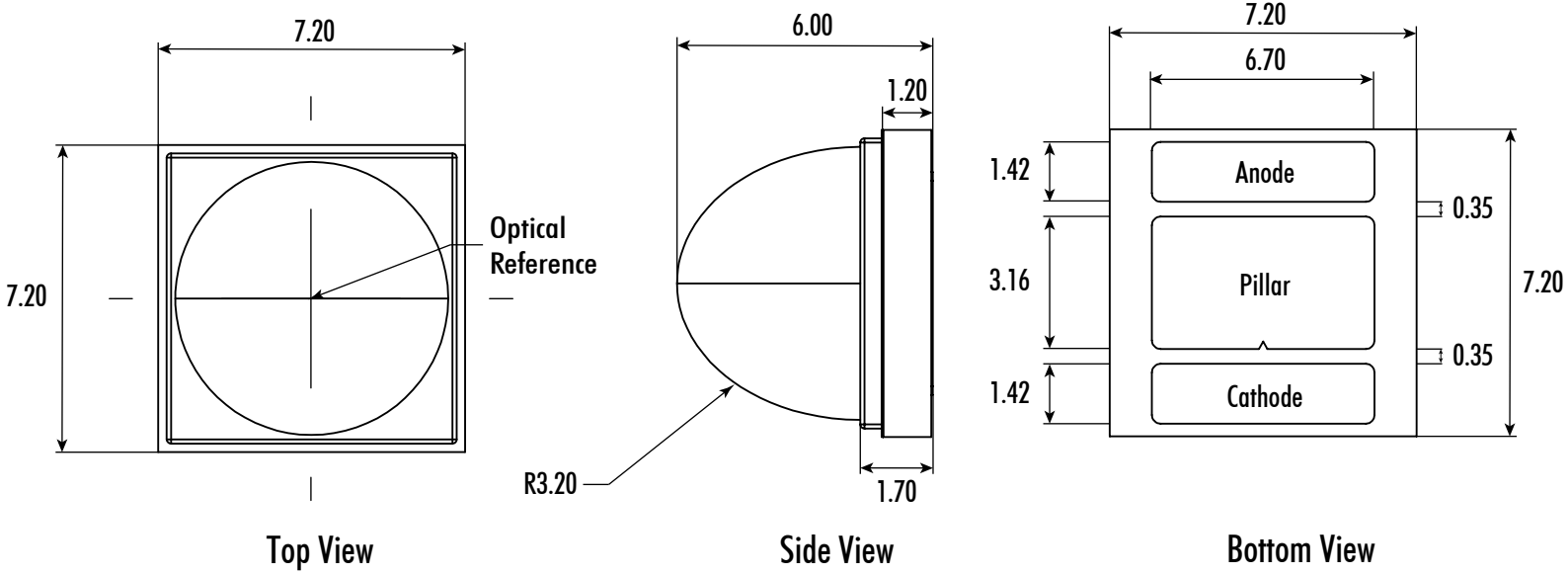

Radiation Pattern

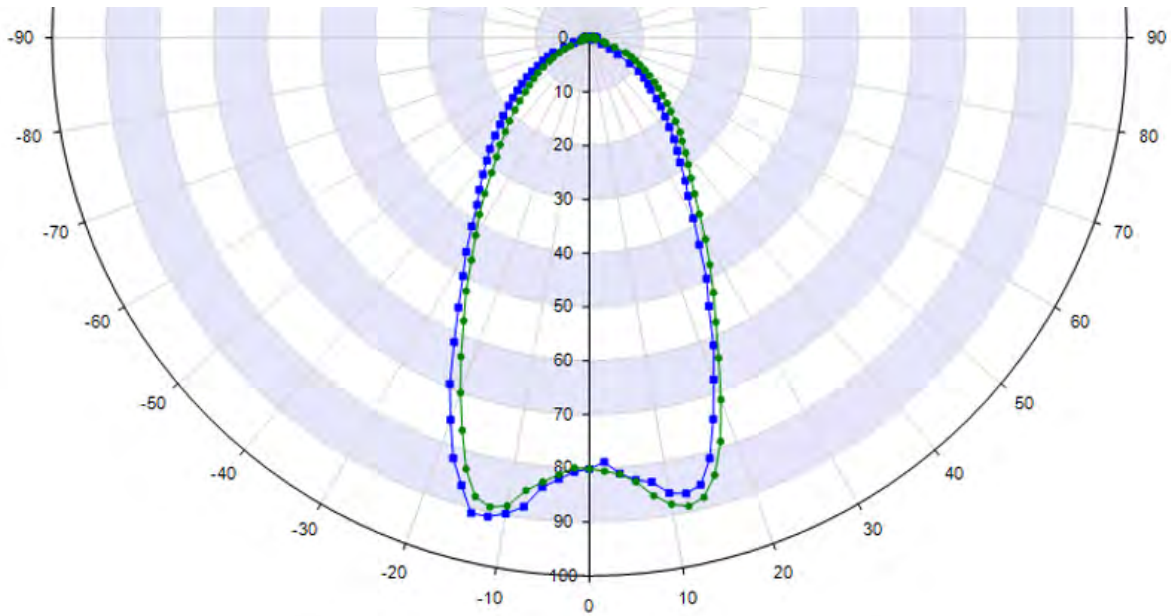

Spectral Output

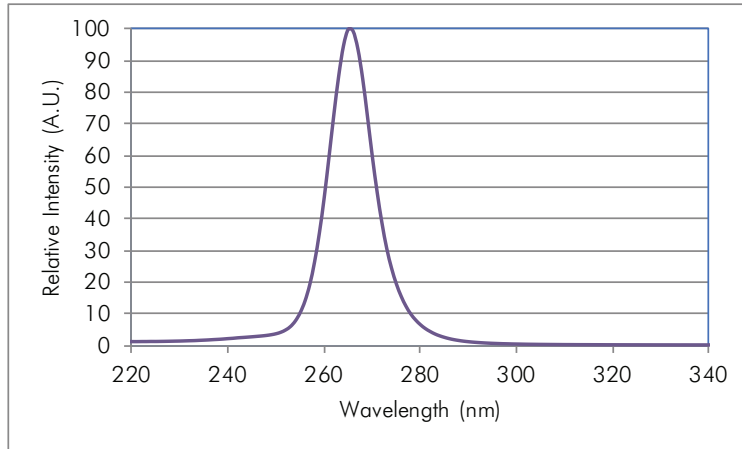

Forward Current vs. Relative Radiant Flux

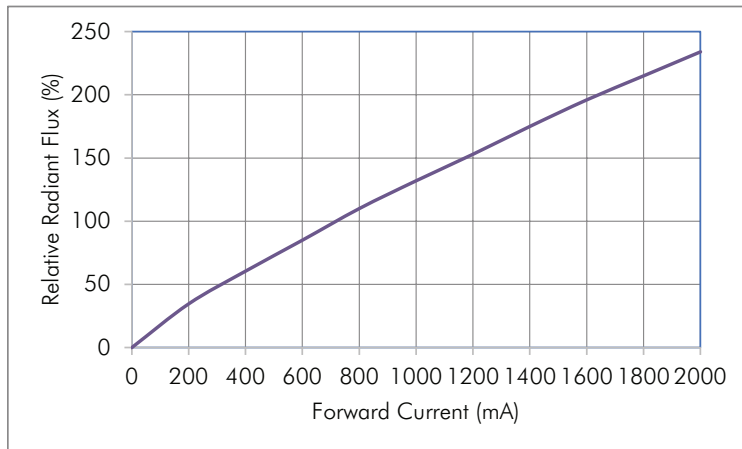

Forward Voltage vs. Forward Current

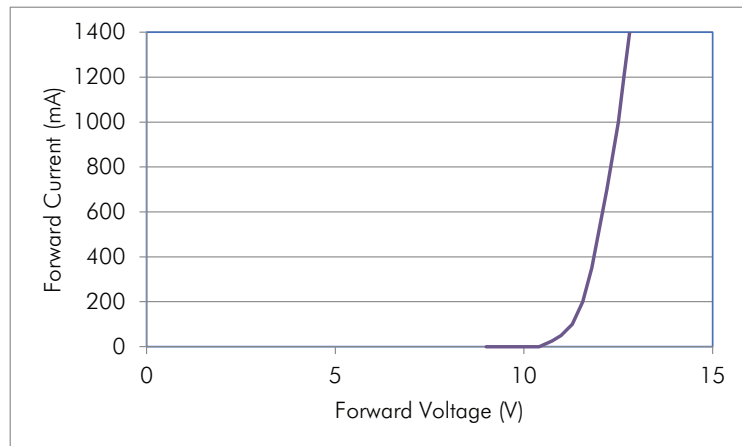

Soldering Guidelines

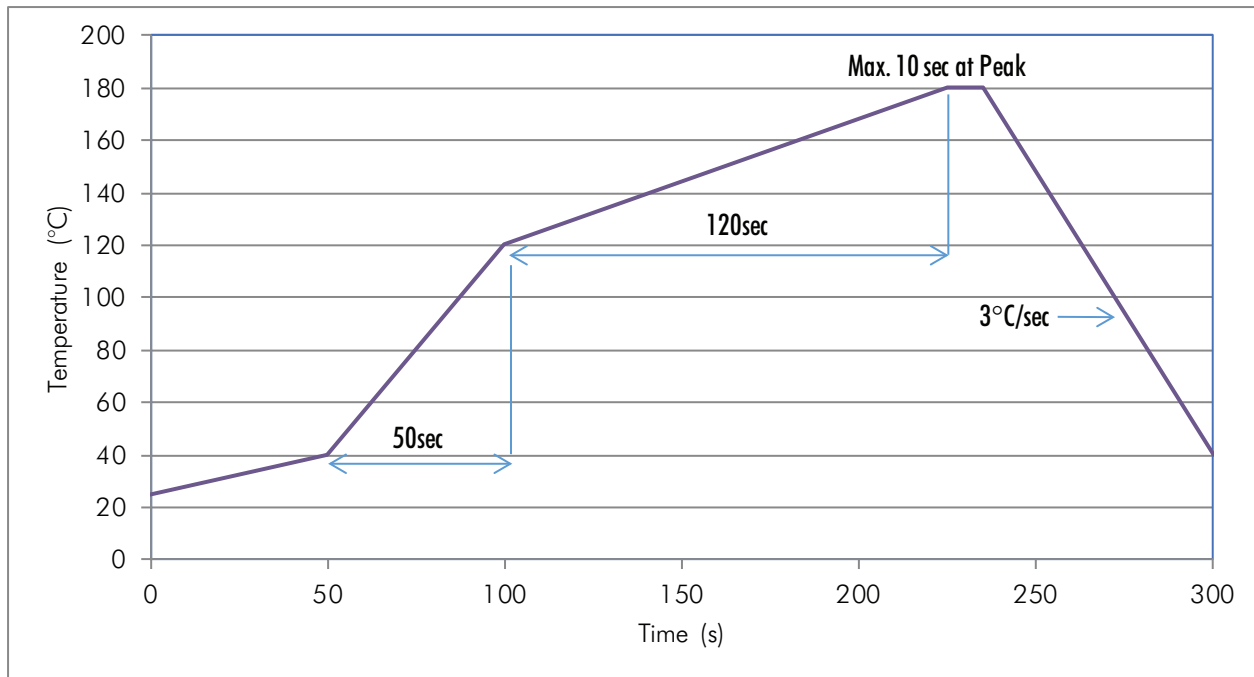

Recommended MCPCB

Violumas recommends the use of the Pillar MCPCB with Violumas LEDs for maximum performance and reliability. The data presented in this document is measured from the use of exclusive Flip Chip Opto patented products - the 3-PAD LED Flip Chip and the Pillar MCPCB. Please consult the Violumas engineering team for further recommendations on MCPCB options.

Handling & Usage Precautions

- Exhibit extreme care when handling LEDs. Do not touch the LED with bare hands as doing so may contaminate and affect the optical characteristics of the LED. When using tweezers, do not apply excessive force, especially to the glass lens. Do not drop the LED as doing so may cause product damage.
- Ensure that electrostatic discharge specifications are followed. Static electricity and surge voltages may cause product damage. Proper electrostatic discharge protection equipment, working machinery, and protected mounting equipment are recommended.
- Do not expose the LEDs to volatile organic compounds as well as hazardous, acidic, and corrosive substances during storage and operation to avoid product damage.
- Do not apply excess mechanical force and vibration while handling the product.
- Do not expose the product to sudden changes in temperature, high humidity levels, and condensation.
- Ensure that the PCB is suitable for the product and be wary of LED placement and possible PCB warpage.
- To avoid fault issues, do not couple any electrical wires to the metal substrate of the MCPCB or COB. If any electrical wires from the power source have contact with the MCPCB's metal base under power ON conditions, permanent damage may occur due to inner arcing within the 3-PAD LED structure.

Storage Precautions

- Perform soldering as soon as the moisture-proof packaging is opened.
- After the storage duration has exceeded the recommended time, products may need to be baked before soldering.
- Store all products in a controlled environment under 30° C free of dust. Do not expose the product to sudden changes in temperature, high humidity levels, and condensation.
- Please consult the Violumas engineering team for further information on storage precautions.

Eye Safety Precautions

- Avoid exposure to UV light during LED operation. Do not look directly into the UV light during LED operation. Do not look directly into the UV light during optical measurements even through optical instruments. Protect the body, skin, and eyes with UV protective equipment.
- Attach warning labels on all products and systems that use UV LEDs.

Cleaning Precautions

- Do not use brushes or organic solvents for cleaning the LEDs.
- Perform electrical and optical measurements before and after cleaning to ensure optimal performance.

Static Electricity Precautions

- Ensure that equipment and machinery are properly grounded.
- Anti-electrostatic attire (wristbands, gloves, footwear, etc.) is recommended.
- Damage inspection is recommended while performing characteristics inspection of LEDs.

Disclaimers

Violumas is not responsible for any damages that result from inaccurate use of the recommended guidelines. The information compiled in this document is a result of careful review of reference materials and reliable sources. Violumas does not make any claims regarding warranty or guarantee. It is recommended that each customer consults the Violumas engineering team before engaging Violumas products in extreme applications where the failure of the LED and damage to human health may be possible. Each user assumes full responsibility for determining the suitability of the use of Violumas products in various applications. Disassembling Violumas products without consent is prohibited. No part of these documents may be reproduced in any form without prior written permission from Violumas. Please note that the data presented in this document is measured from the use of exclusive Flip Chip Opto patented products - the 3-PAD LED Flip Chip and the Pillar MCPCB.

VC1X1C48L3-265 Mid Power UVC LED COB

VC1X1C48L3-265 is a UV LED Chip on Board (COB) module offering UV radiation at a peak wavelength of $265\pm 5\text{nm}$. Each COB is structured based on the patented 3-PAD LED Flip Chip mounted directly onto the Super Pillar MCPCB to further boost output efficiency and decrease the thermal resistance. The VC1X1C48L3 series is ready for plug and play with no soldering required and is equipped with a 30° lens for mid power UV output.

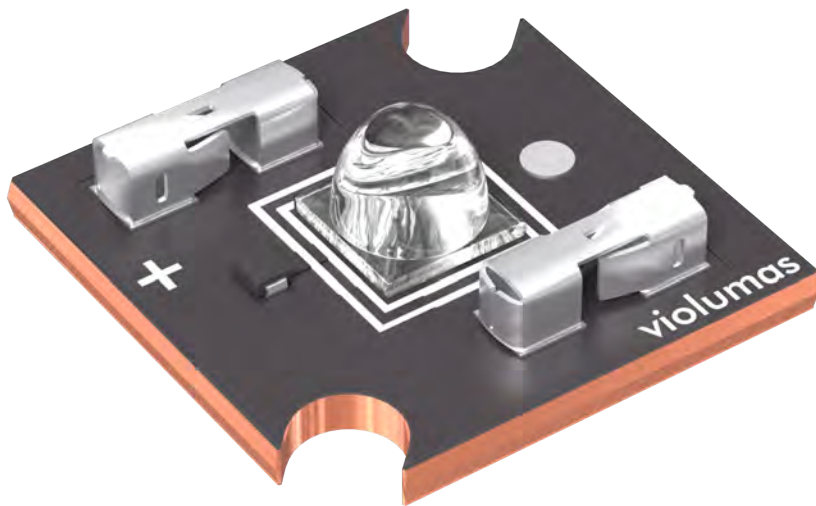

FEATURES & BENEFITS

- Dimensions: 15x15x4.27mm
- Ready for plug and play (solder-free)
- Equipped with 30° fused silica lens
- TVS built in for ESD protection

THE VIOLUMAS DIFFERENCE

- 3-PAD flip chip structure
- Lowest thermal resistance at 0.9°C/W
- Minimal thermal decay with higher output
- Industry-leading reliability & lifetime

Electro-Optical Characteristics at T=25°C and I_F = 700mA

Parameter	Symbol	Unit	Min	Typical	Max
Peak Wavelength	λ_p	nm	260	265	270
Forward Voltage	V _F	V	-	6.4	-
Radiant Flux	P _O	mW	70	82	86
Full Width of Half Magnitude	$\Delta\lambda$	nm	-	13	-
Radiant Angle	2 $\Phi_{1/2}$	Degree	-	30	-
Thermal Resistance, Junction to Solder Joint	R _{th} (J-S)	°C/W	-	0.9	-

Absolute Maximum Ratings

Parameter	Symbol	Unit	Value
Forward Current	I _F	mA	1000
Reverse Voltage	V _R	V	5
Power	P _O	W	6.5
Junction Temperature	T _J	°C	120
Operating Temperature	T _{OPR}	°C	-30 ~ 85
Storage Temperature	T _{STG}	°C	-40 ~ 100

Reliability

Test	Condition	Test Duration	Test Failed/Tested
Thermal Shock	-45°C ~ 125°C	2000 Cycles	0/10

Product Overview

COB modules are ready for plug and play with no soldering required. All Violumas COBs are equipped with connectors for direct wiring and TVS protection against ESD and voltage issues.

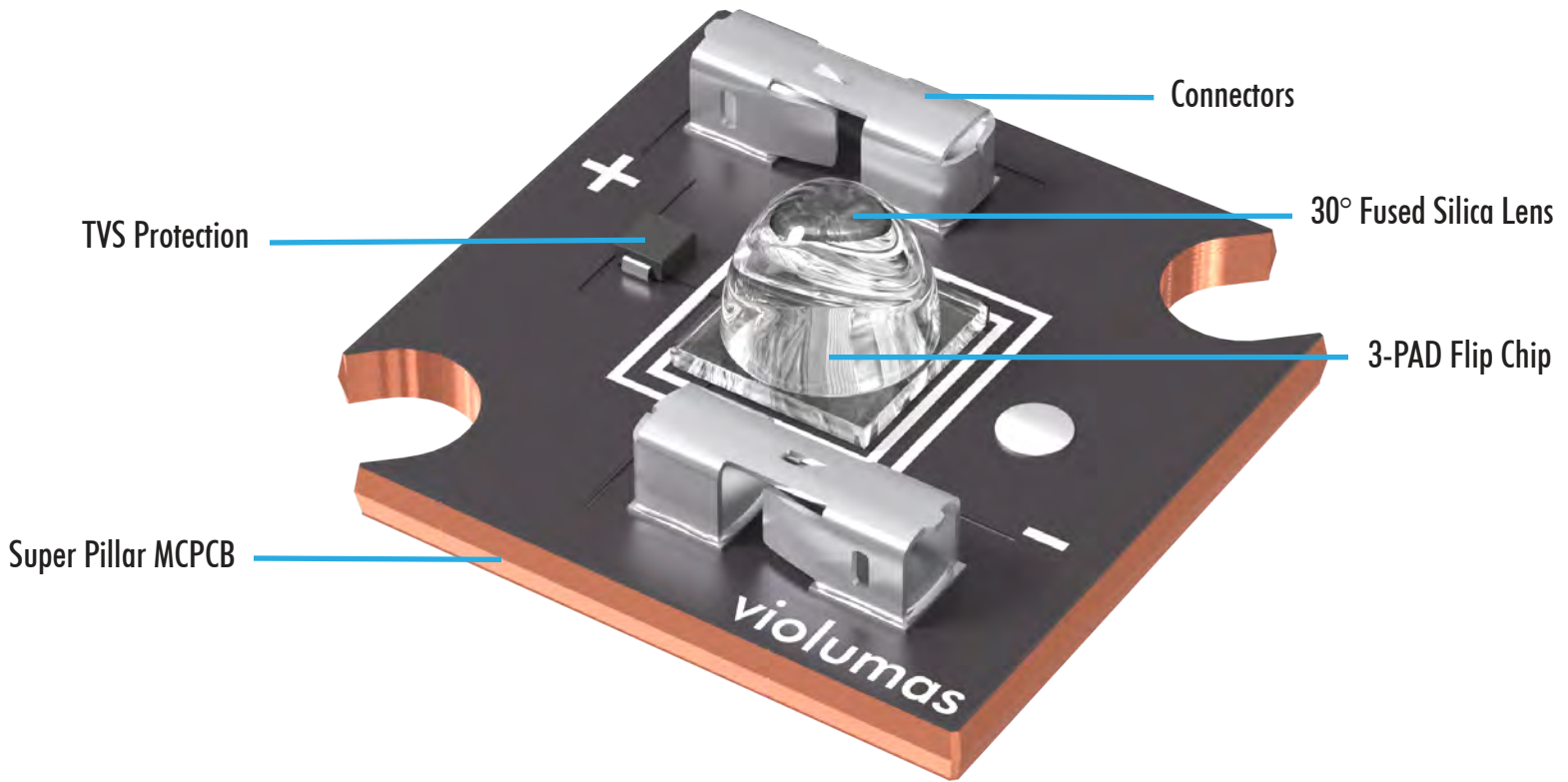

Radiation Pattern

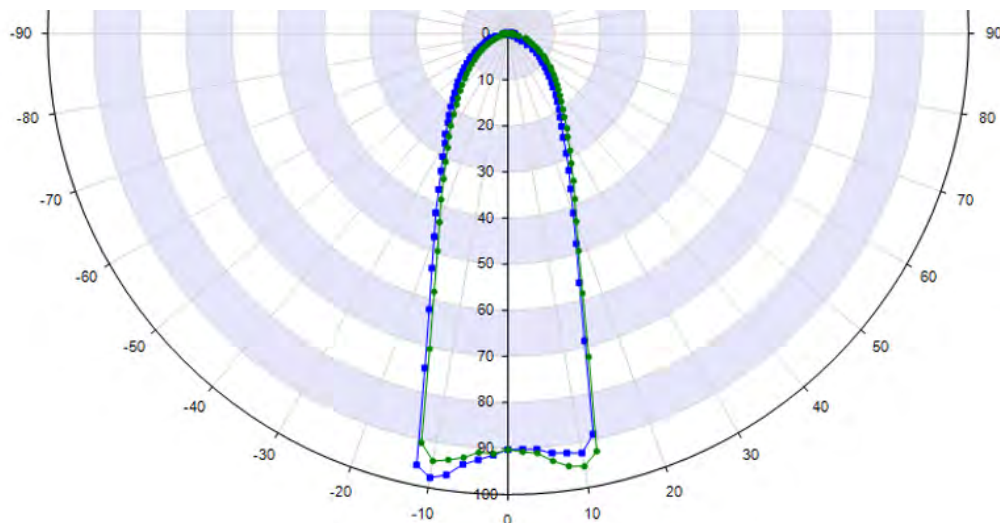

Spectral Output

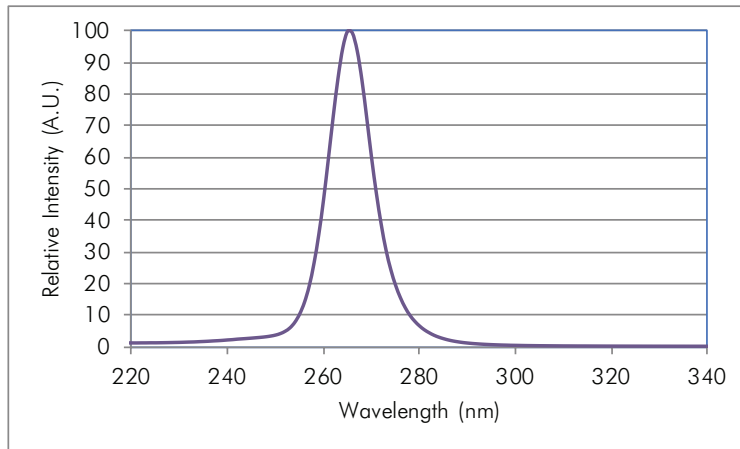

Forward Current vs. Relative Radiant Flux

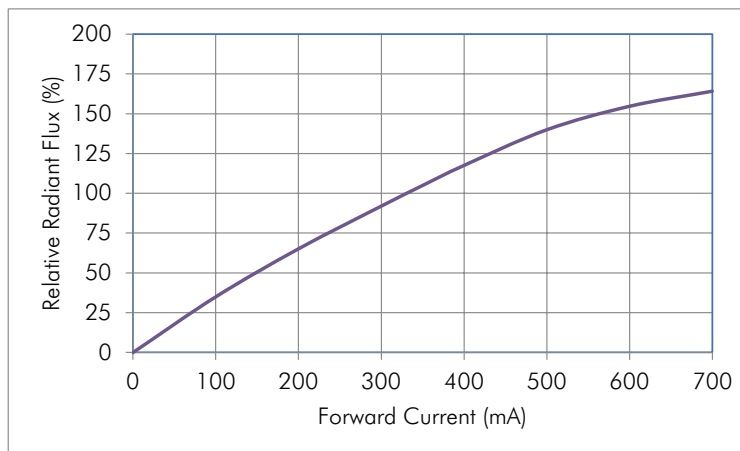

Forward Voltage vs. Forward Current

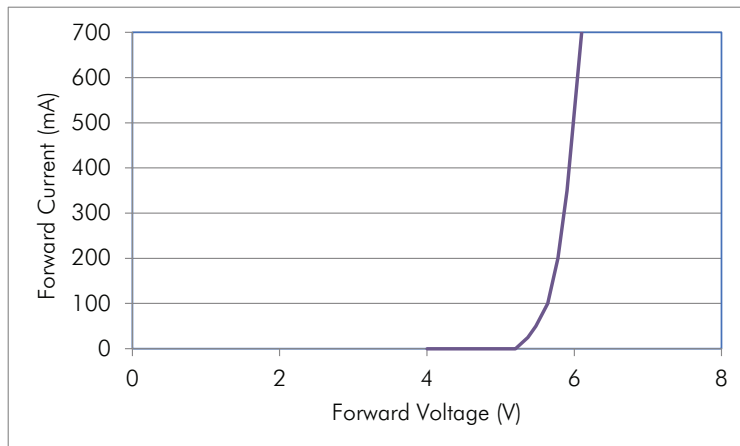

Handling & Usage Precautions

- Exhibit extreme care when handling LEDs. Do not touch the LED with bare hands as doing so may contaminate and affect the optical characteristics of the LED. When using tweezers, do not apply excessive force, especially to the glass lens. Do not drop the LED as doing so may cause product damage.
- Ensure that electrostatic discharge specifications are followed. Static electricity and surge voltages may cause product damage. Proper electrostatic discharge protection equipment, working machinery, and protected mounting equipment are recommended.
- Do not expose the LEDs to volatile organic compounds as well as hazardous, acidic, and corrosive substances during storage and operation to avoid product damage.
- Do not apply excess mechanical force and vibration while handling the product.
- Do not expose the product to sudden changes in temperature, high humidity levels, and condensation.
- Ensure that the PCB is suitable for the product and be wary of LED placement and possible PCB warpage.
- To avoid fault issues, do not couple any electrical wires to the metal substrate of the MCPCB or COB. If any electrical wires from the power source have contact with the MCPCB's metal base under power ON conditions, permanent damage may occur due to inner arcing within the 3-PAD LED structure.

Storage Precautions

- Perform soldering as soon as the moisture-proof packaging is opened.
- After the storage duration has exceeded the recommended time, products may need to be baked before soldering.
- Store all products in a controlled environment under 30° C free of dust. Do not expose the product to sudden changes in temperature, high humidity levels, and condensation.
- Please consult the Violumas engineering team for further information on storage precautions.

Eye Safety Precautions

- Avoid exposure to UV light during LED operation. Do not look directly into the UV light during LED operation. Do not look directly into the UV light during optical measurements even through optical instruments. Protect the body, skin, and eyes with UV protective equipment.
- Attach warning labels on all products and systems that use UV LEDs.

Cleaning Precautions

- Do not use brushes or organic solvents for cleaning the LEDs.
- Perform electrical and optical measurements before and after cleaning to ensure optimal performance.

Static Electricity Precautions

- Ensure that equipment and machinery are properly grounded.
- Anti-electrostatic attire (wristbands, gloves, footwear, etc.) is recommended.
- Damage inspection is recommended while performing characteristics inspection of LEDs.

Disclaimers

Violumas is not responsible for any damages that result from inaccurate use of the recommended guidelines. The information compiled in this document is a result of careful review of reference materials and reliable sources. Violumas does not make any claims regarding warranty or guarantee. It is recommended that each customer consults the Violumas engineering team before engaging Violumas products in extreme applications where the failure of the LED and damage to human health may be possible. Each user assumes full responsibility for determining the suitability of the use of Violumas products in various applications. Disassembling Violumas products without consent is prohibited. No part of these documents may be reproduced in any form without prior written permission from Violumas. Please note that the data presented in this document is measured from the use of exclusive Flip Chip Opto patented products - the 3-PAD LED Flip Chip and the Pillar MCPCB.

VC2X2C48L6-265 High Power UVC LED COB

VC2X2C48L6-265 is a UV LED Chip on Board (COB) module offering UV radiation at a peak wavelength of $265 \pm 5\text{nm}$. Each COB is structured based on the patented 3-PAD LED Flip Chip mounted directly onto the Super Pillar MCPCB to further boost output efficiency and decrease the thermal resistance. The VC2X2C48L6 series is ready for plug and play with no soldering required and is equipped with a 60° lens for high power UV output.

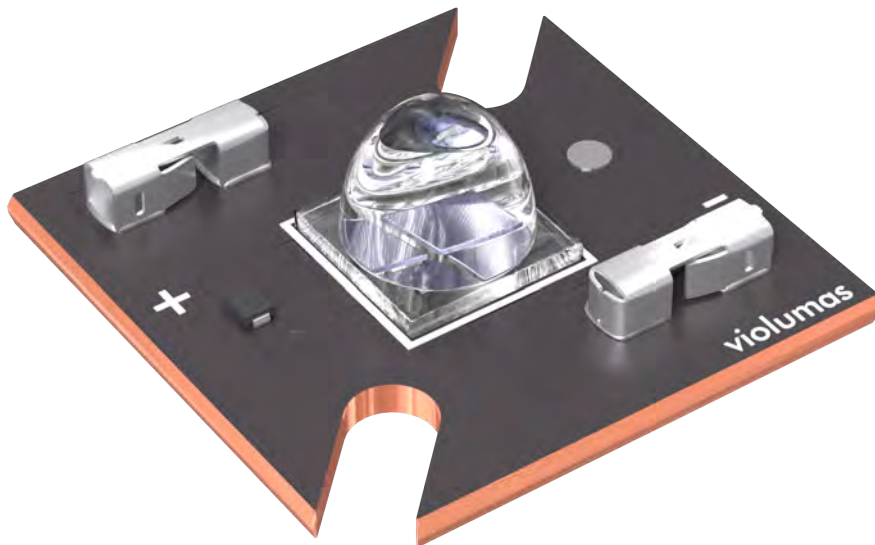

FEATURES & BENEFITS

- Dimensions: 20x20x6.1 mm
- Ready for plug and play (solder-free)
- Equipped with 60° fused silica lens
- TVS built in for ESD protection

THE VIOLUMAS DIFFERENCE

- 3-PAD flip chip structure
- Lowest thermal resistance at 0.32°C/W
- Minimal thermal decay with higher output
- Industry-leading reliability & lifetime

Electro-Optical Characteristics at T=25°C and I_F = 1400mA

Parameter	Symbol	Unit	Min	Typical	Max
Peak Wavelength	λ_p	nm	260	265	270
Forward Voltage	V _F	V	-	12.8	-
Radiant Flux	P _O	mW	270	320	335
Full Width of Half Magnitude	$\Delta\lambda$	nm	-	13	-
Radiant Angle	2 $\Phi_{1/2}$	Degree	-	60	-
Thermal Resistance, Junction to Solder Joint	R _{th(J-S)}	°C/W	-	0.32	-

Absolute Maximum Ratings

Parameter	Symbol	Unit	Value
Forward Current	I _F	mA	2000
Reverse Voltage	V _R	V	10
Power	P _O	W	26
Junction Temperature	T _J	°C	120
Operating Temperature	T _{OPR}	°C	-30 ~ 85
Storage Temperature	T _{STG}	°C	-40 ~ 100

Reliability

Test	Condition	Test Duration	Test Failed/Tested
Thermal Shock	-45°C ~ 125°C	2000 Cycles	0/10

Product Overview

COB modules are ready for plug and play with no soldering required. All Violumas COBs are equipped with connectors for direct wiring and TVS protection against ESD and voltage issues.

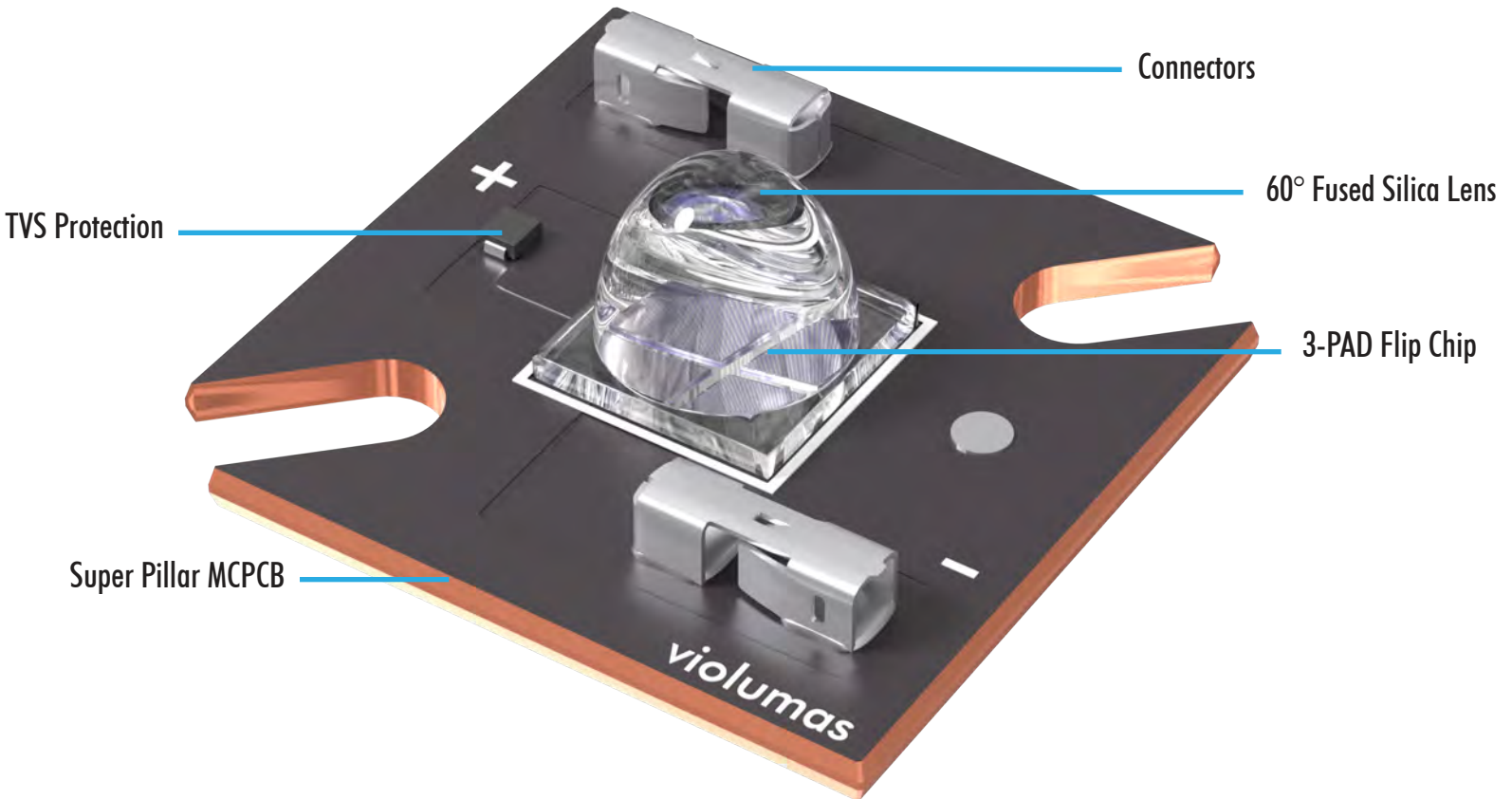

Radiation Pattern

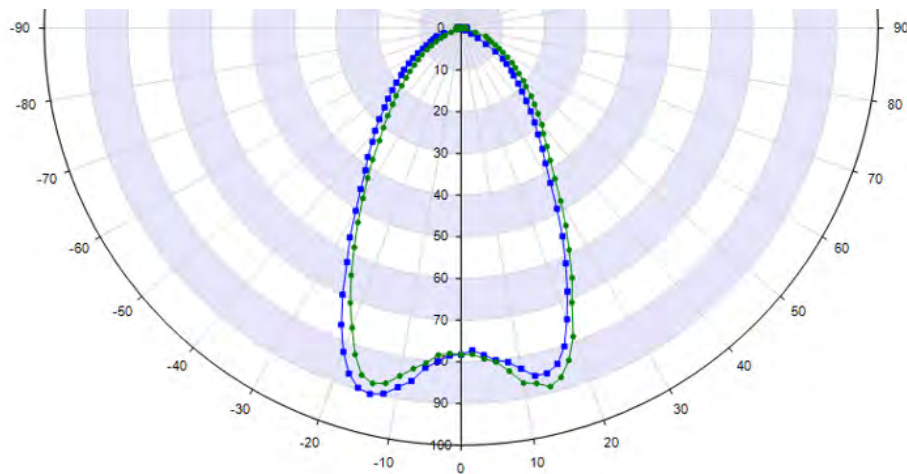

Spectral Output

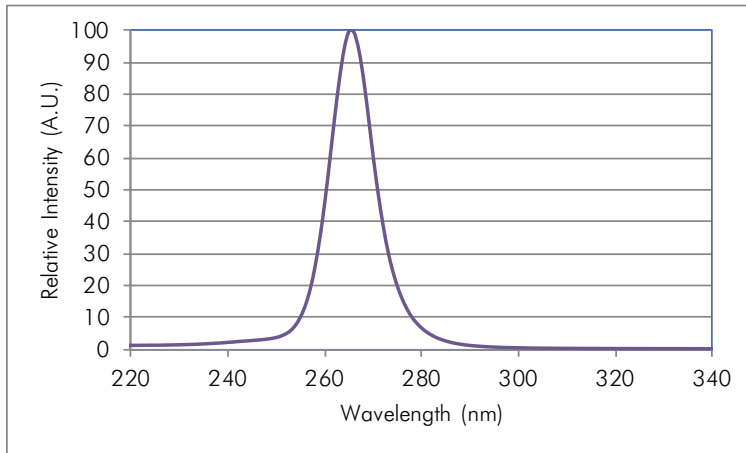

Forward Current vs. Relative Radiant Flux

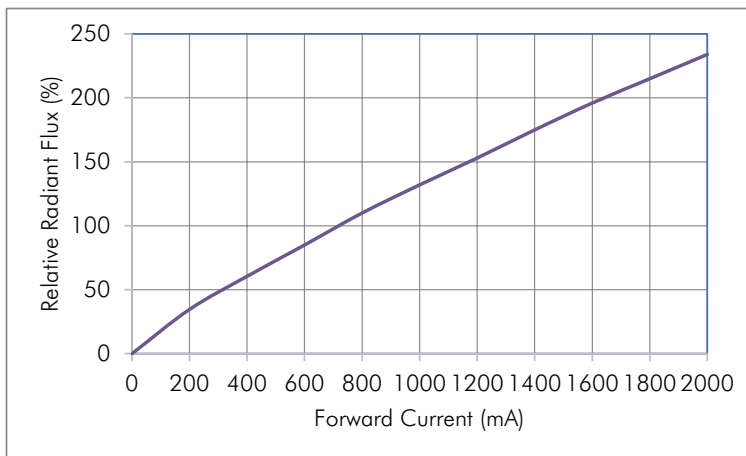

Forward Voltage vs. Forward Current

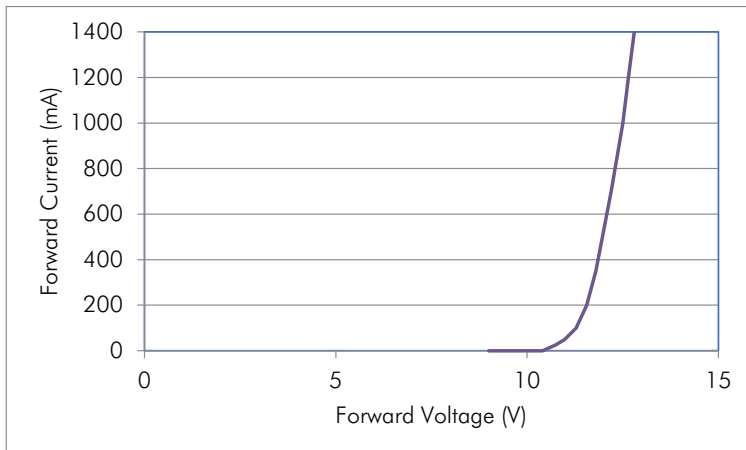

Handling & Usage Precautions

- Exhibit extreme care when handling LEDs. Do not touch the LED with bare hands as doing so may contaminate and affect the optical characteristics of the LED. When using tweezers, do not apply excessive force, especially to the glass lens. Do not drop the LED as doing so may cause product damage.
- Ensure that electrostatic discharge specifications are followed. Static electricity and surge voltages may cause product damage. Proper electrostatic discharge protection equipment, working machinery, and protected mounting equipment are recommended.
- Do not expose the LEDs to volatile organic compounds as well as hazardous, acidic, and corrosive substances during storage and operation to avoid product damage.
- Do not apply excess mechanical force and vibration while handling the product.
- Do not expose the product to sudden changes in temperature, high humidity levels, and condensation.
- Ensure that the PCB is suitable for the product and be wary of LED placement and possible PCB warpage.
- To avoid fault issues, do not couple any electrical wires to the metal substrate of the MCPCB or COB. If any electrical wires from the power source have contact with the MCPCB's metal base under power ON conditions, permanent damage may occur due to inner arcing within the 3-PAD LED structure.

Storage Precautions

- Perform soldering as soon as the moisture-proof packaging is opened.
- After the storage duration has exceeded the recommended time, products may need to be baked before soldering.
- Store all products in a controlled environment under 30° C free of dust. Do not expose the product to sudden changes in temperature, high humidity levels, and condensation.
- Please consult the Violumas engineering team for further information on storage precautions.

Eye Safety Precautions

- Avoid exposure to UV light during LED operation. Do not look directly into the UV light during LED operation. Do not look directly into the UV light during optical measurements even through optical instruments. Protect the body, skin, and eyes with UV protective equipment.
- Attach warning labels on all products and systems that use UV LEDs.

Cleaning Precautions

- Do not use brushes or organic solvents for cleaning the LEDs.
- Perform electrical and optical measurements before and after cleaning to ensure optimal performance.

Static Electricity Precautions

- Ensure that equipment and machinery are properly grounded.
- Anti-electrostatic attire (wristbands, gloves, footwear, etc.) is recommended.
- Damage inspection is recommended while performing characteristics inspection of LEDs.

Disclaimers

Violumas is not responsible for any damages that result from inaccurate use of the recommended guidelines. The information compiled in this document is a result of careful review of reference materials and reliable sources. Violumas does not make any claims regarding warranty or guarantee. It is recommended that each customer consults the Violumas engineering team before engaging Violumas products in extreme applications where the failure of the LED and damage to human health may be possible. Each user assumes full responsibility for determining the suitability of the use of Violumas products in various applications. Disassembling Violumas products without consent is prohibited. No part of these documents may be reproduced in any form without prior written permission from Violumas. Please note that the data presented in this document is measured from the use of exclusive Flip Chip Opto patented products - the 3-PAD LED Flip Chip and the Pillar MCPCB.

VC3X3C48L9-265 3X3 UVC LED COB

VC3X3C48L9-265 is a UV LED Chip on Board (COB) module offering UV radiation at a peak wavelength of $265 \pm 5\text{nm}$. Each COB is structured based on the patented 3-PAD LED Flip Chip mounted directly onto the Super Pillar MCPCB to further boost output efficiency and decrease the thermal resistance. The VC3X3C48L9 series is ready for plug and play with no soldering required and is equipped with a 90° lens for high power UV output.

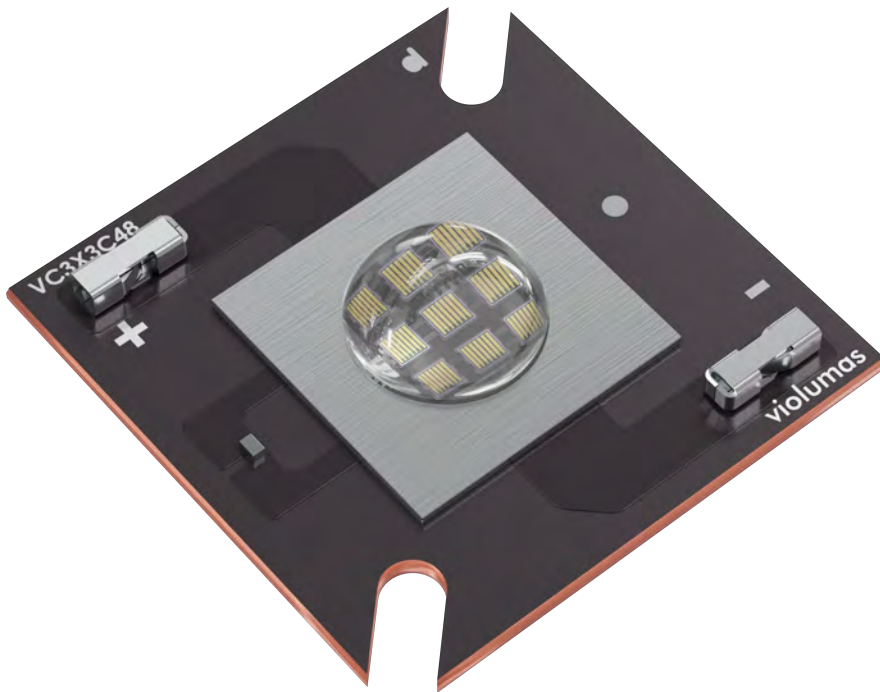

FEATURES & BENEFITS

- Dimensions: 30mm x 30mm x 6.15mm
- Ready for plug and play (solder-free)
- Equipped with 90° fused silica lens
- TVS built in for ESD protection

THE VIOLUMAS DIFFERENCE

- 3-PAD flip chip structure
- Lowest thermal resistance at 0.1°C/W
- Minimal thermal decay with higher output
- Industry-leading reliability & lifetime

Electro-Optical Characteristics at T=25°C and I_F = 2100mA

Parameter	Symbol	Unit	Min	Typical	Max
Peak Wavelength	λ_p	nm	260	265	270
Forward Voltage	V _F	V	15.5	18.0	20.0
Radiant Flux	P _O	mW	580	635	720
Full Width of Half Magnitude	$\Delta\lambda$	nm	-	12	-
Radiant Angle	2 $\Phi_{1/2}$	Degree	-	90	-
Thermal Resistance, Junction to Solder Joint	R _{th(J-S)}	°C/W	-	0.1	-

Absolute Maximum Ratings

Parameter	Symbol	Unit	Value
Forward Current	I _F	mA	3000
Reverse Voltage	V _R	V	15
Power	P _D	W	58.5
Junction Temperature	T _J	°C	90
Operating Temperature	T _{OPR}	°C	-30 ~ 85
Storage Temperature	T _{STG}	°C	-40 ~ 85

Product Overview

COB modules are ready for plug and play with no soldering required. All Violumas COBs are equipped with connectors for direct wiring and TVS protection against ESD and voltage issues.

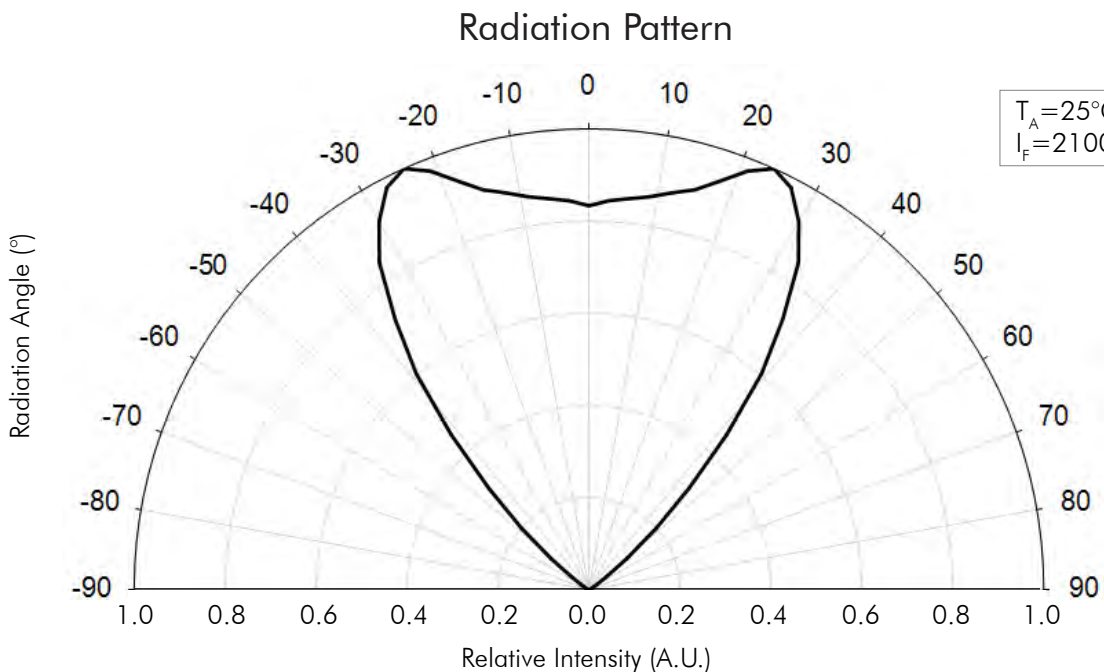
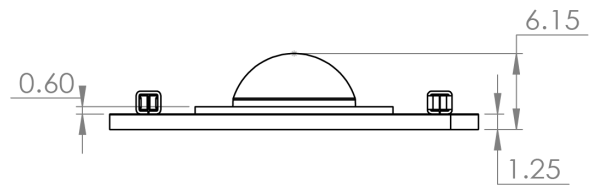
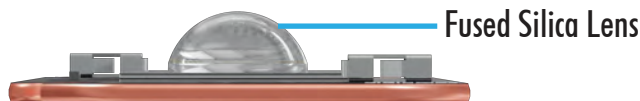
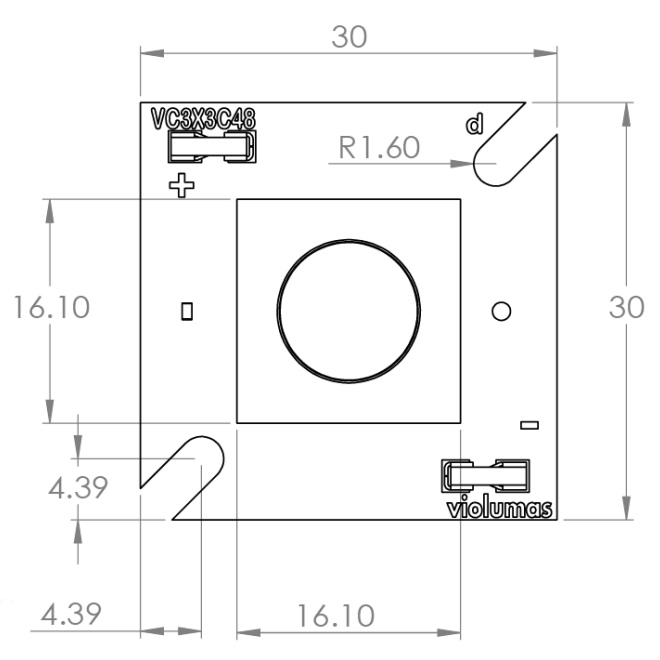
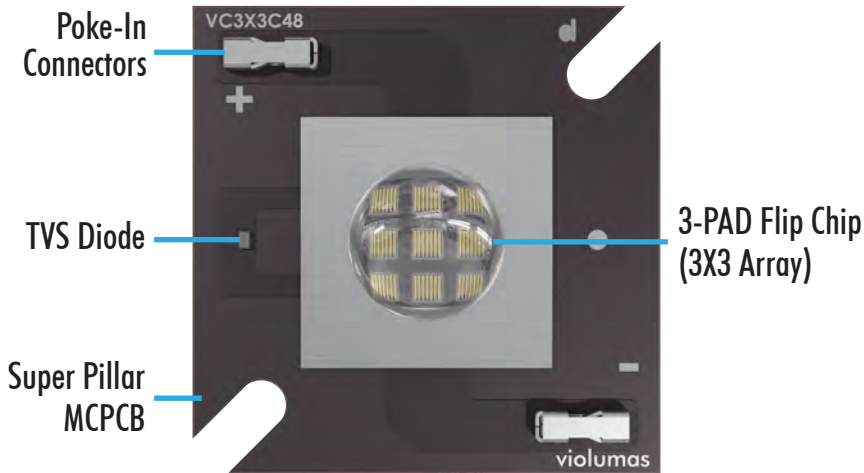

Spectral Output

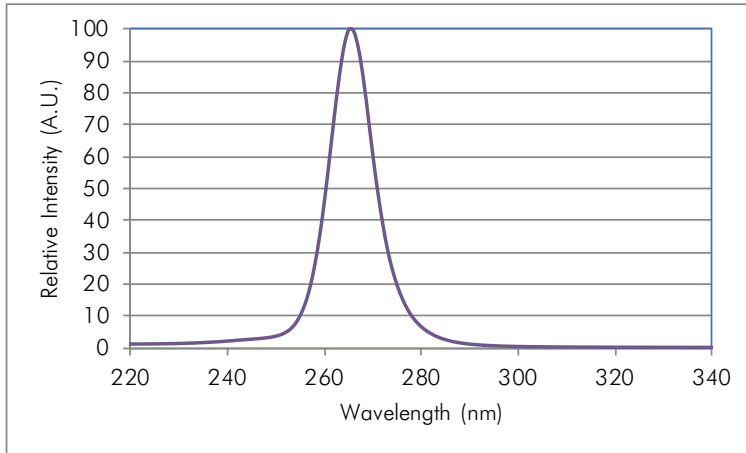

Forward Current vs. Relative Radiant Flux

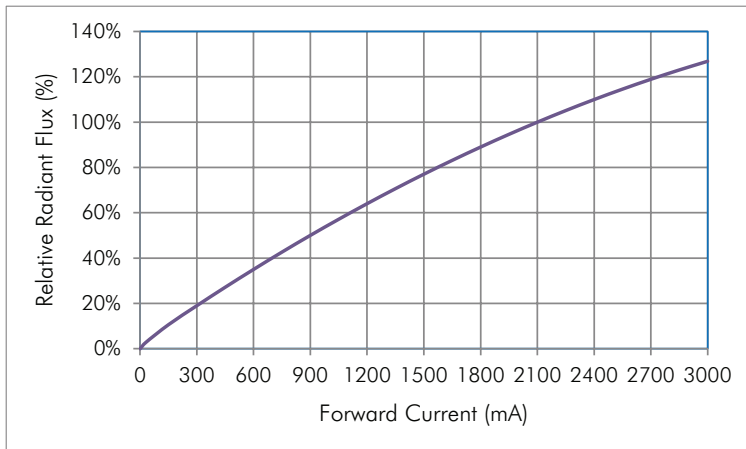

Forward Voltage vs. Forward Current

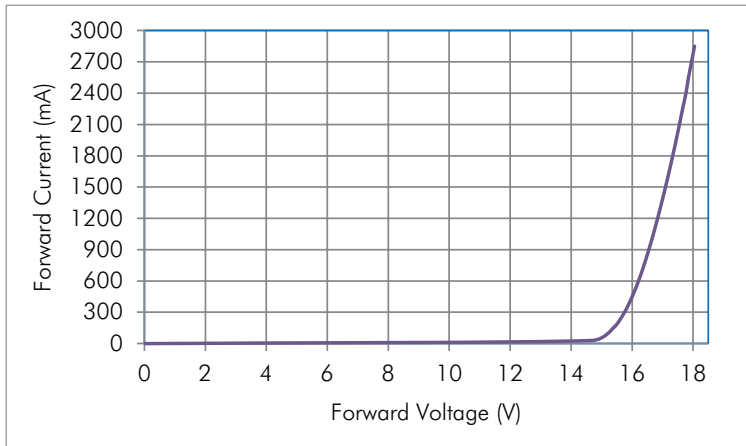

Handling & Usage Precautions

- Exhibit extreme care when handling LEDs. Do not touch the LED with bare hands as doing so may contaminate and affect the optical characteristics of the LED. When using tweezers, do not apply excessive force, especially to the glass lens. Do not drop the LED as doing so may cause product damage.
- Ensure that electrostatic discharge specifications are followed. Static electricity and surge voltages may cause product damage. Proper electrostatic discharge protection equipment, working machinery, and protected mounting equipment are recommended.
- Do not expose the LEDs to volatile organic compounds as well as hazardous, acidic, and corrosive substances during storage and operation to avoid product damage.
- Do not apply excess mechanical force and vibration while handling the product.
- Do not expose the product to sudden changes in temperature, high humidity levels, and condensation.
- Ensure that the PCB is suitable for the product and be wary of LED placement and possible PCB warpage.
- To avoid fault issues, do not couple any electrical wires to the metal substrate of the MCPCB or COB. If any electrical wires from the power source have contact with the MCPCB's metal base under power ON conditions, permanent damage may occur due to inner arcing within the 3-PAD LED structure.

Storage Precautions

- Perform soldering as soon as the moisture-proof packaging is opened.
- After the storage duration has exceeded the recommended time, products may need to be baked before soldering.
- Store all products in a controlled environment under 30° C free of dust. Do not expose the product to sudden changes in temperature, high humidity levels, and condensation.
- Please consult the Violumas engineering team for further information on storage precautions.

Eye Safety Precautions

- Avoid exposure to UV light during LED operation. Do not look directly into the UV light during LED operation. Do not look directly into the UV light during optical measurements even through optical instruments. Protect the body, skin, and eyes with UV protective equipment.
- Attach warning labels on all products and systems that use UV LEDs.

Cleaning Precautions

- Do not use brushes or organic solvents for cleaning the LEDs.
- Perform electrical and optical measurements before and after cleaning to ensure optimal performance.

Static Electricity Precautions

- Ensure that equipment and machinery are properly grounded.
- Anti-electrostatic attire (wristbands, gloves, footwear, etc.) is recommended.
- Damage inspection is recommended while performing characteristics inspection of LEDs.

Disclaimers

Violumas is not responsible for any damages that result from inaccurate use of the recommended guidelines. The information compiled in this document is a result of careful review of reference materials and reliable sources. Violumas does not make any claims regarding warranty or guarantee. It is recommended that each customer consults the Violumas engineering team before engaging Violumas products in extreme applications where the failure of the LED and damage to human health may be possible. Each user assumes full responsibility for determining the suitability of the use of Violumas products in various applications. Disassembling Violumas products without consent is prohibited. No part of these documents may be reproduced in any form without prior written permission from Violumas. Please note that the data presented in this document is measured from the use of exclusive Flip Chip Opto patented products - the 3-PAD LED Flip Chip and the Pillar MCPCB.

VC4X4C48L9-265 4X4 UVC LED COB

VC4X4C48L9-265 is a UV LED Chip on Board (COB) module offering UV radiation at a peak wavelength of $265 \pm 5\text{nm}$. Each COB is structured based on the patented 3-PAD LED Flip Chip mounted directly onto the Super Pillar MCPCB to further boost output efficiency and decrease the thermal resistance. The VC4X4C48L9 series is ready for plug and play with no soldering required and is equipped with a 90° lens for high power UV output.

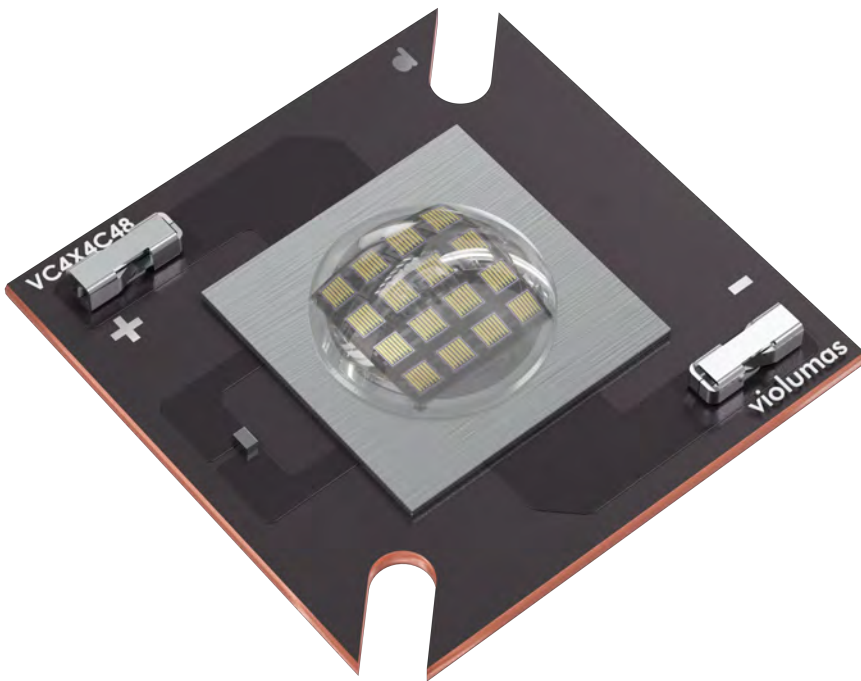

FEATURES & BENEFITS

- Dimensions: 30mm x 30mm x 5.45mm
- Ready for plug and play (solder-free)
- Equipped with 90° fused silica lens
- TVS built in for ESD protection

THE VIOLUMAS DIFFERENCE

- 3-PAD flip chip structure
- Lowest thermal resistance at 0.06°C/W
- Minimal thermal decay with higher output
- Industry-leading reliability & lifetime

Electro-Optical Characteristics at T=25°C and I_F = 2800mA

Parameter	Symbol	Unit	Min	Typical	Max
Peak Wavelength	λ_p	nm	260	265	270
Forward Voltage	V _F	V	22.0	24.0	26.5
Radiant Flux	P _O	mW	900	1050	1200
Full Width of Half Magnitude	$\Delta\lambda$	nm	-	12	-
Radiant Angle	2 $\Phi_{1/2}$	Degree	-	90	-
Thermal Resistance, Junction to Solder Joint	R _{th(J-S)}	°C/W	-	0.06	-

Absolute Maximum Ratings

Parameter	Symbol	Unit	Value
Forward Current	I _F	mA	4000
Reverse Voltage	V _R	V	20
Power	P _D	W	104
Junction Temperature	T _J	°C	90
Operating Temperature	T _{OPR}	°C	-30 ~ 85
Storage Temperature	T _{STG}	°C	-40 ~ 85

Product Overview

COB modules are ready for plug and play with no soldering required. All Violumas COBs are equipped with connectors for direct wiring and TVS protection against ESD and voltage issues.

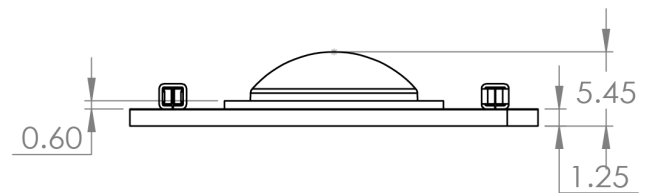
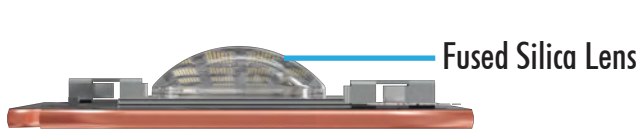
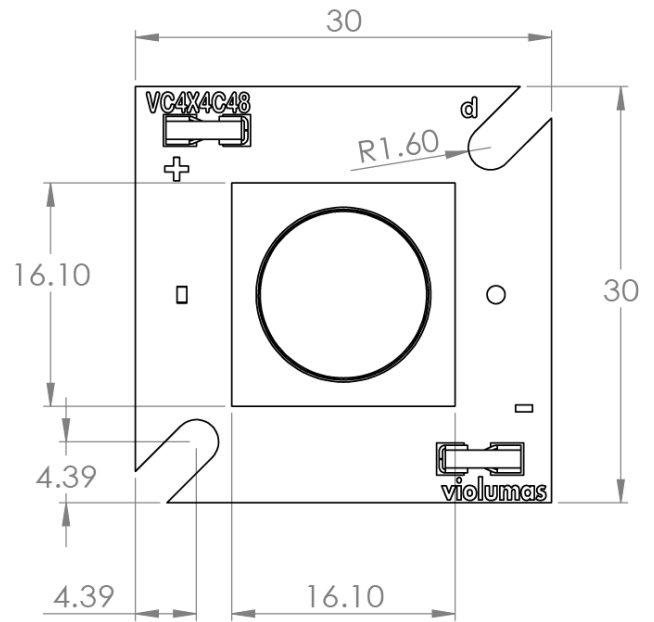
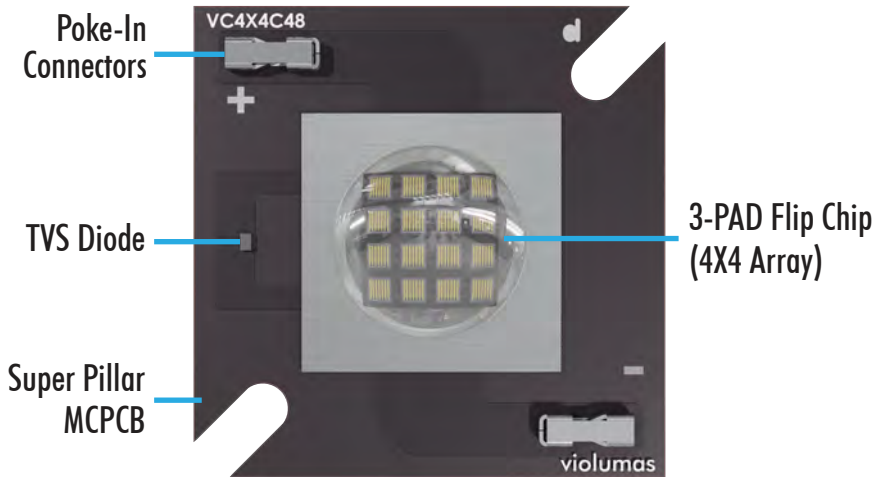

Radiation Pattern

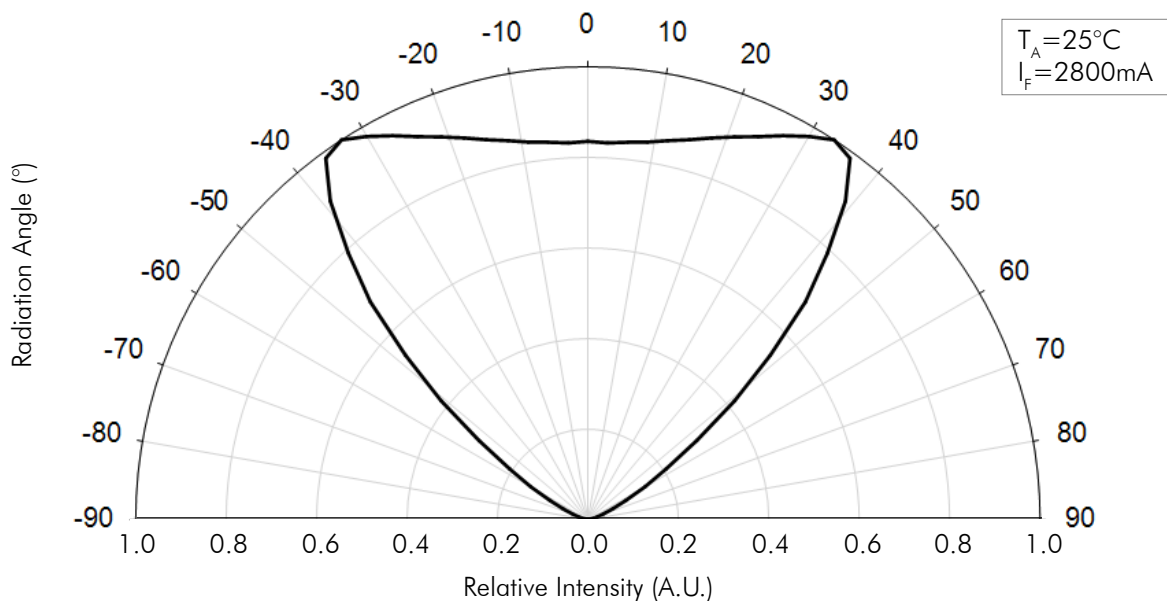

Spectral Output

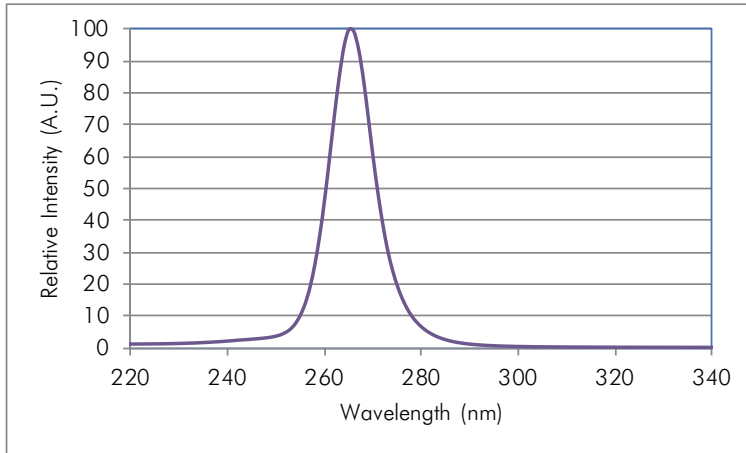

Forward Current vs. Relative Radiant Flux

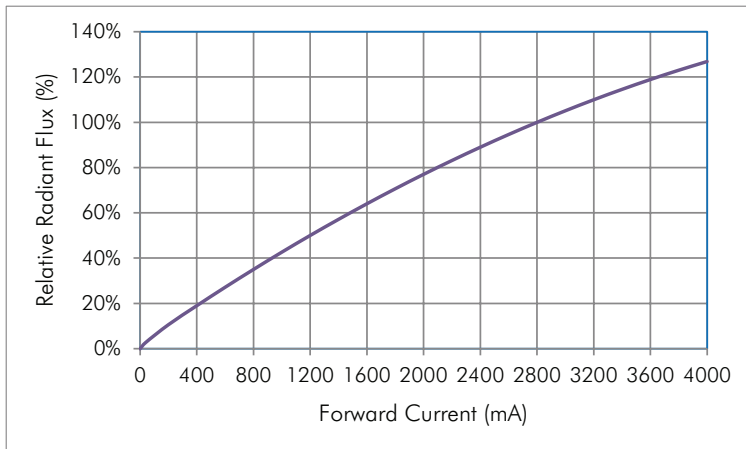

Forward Voltage vs. Forward Current

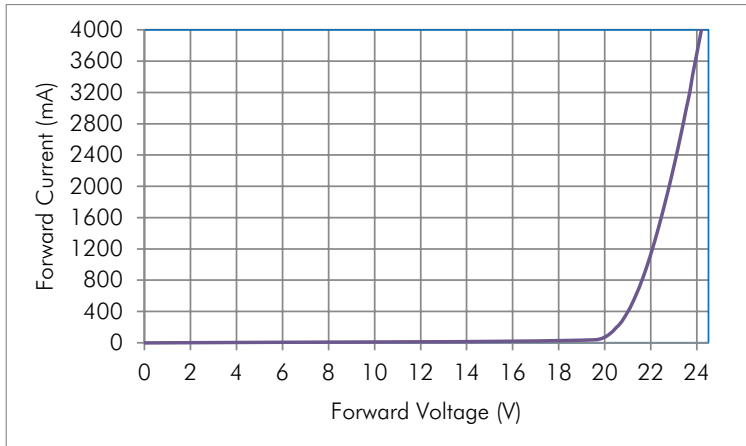

Handling & Usage Precautions

- Exhibit extreme care when handling LEDs. Do not touch the LED with bare hands as doing so may contaminate and affect the optical characteristics of the LED. When using tweezers, do not apply excessive force, especially to the glass lens. Do not drop the LED as doing so may cause product damage.
- Ensure that electrostatic discharge specifications are followed. Static electricity and surge voltages may cause product damage. Proper electrostatic discharge protection equipment, working machinery, and protected mounting equipment are recommended.
- Do not expose the LEDs to volatile organic compounds as well as hazardous, acidic, and corrosive substances during storage and operation to avoid product damage.
- Do not apply excess mechanical force and vibration while handling the product.
- Do not expose the product to sudden changes in temperature, high humidity levels, and condensation.
- Ensure that the PCB is suitable for the product and be wary of LED placement and possible PCB warpage.
- To avoid fault issues, do not couple any electrical wires to the metal substrate of the MCPCB or COB. If any electrical wires from the power source have contact with the MCPCB's metal base under power ON conditions, permanent damage may occur due to inner arcing within the 3-PAD LED structure.

Storage Precautions

- Perform soldering as soon as the moisture-proof packaging is opened.
- After the storage duration has exceeded the recommended time, products may need to be baked before soldering.
- Store all products in a controlled environment under 30° C free of dust. Do not expose the product to sudden changes in temperature, high humidity levels, and condensation.
- Please consult the Violumas engineering team for further information on storage precautions.

Eye Safety Precautions

- Avoid exposure to UV light during LED operation. Do not look directly into the UV light during LED operation. Do not look directly into the UV light during optical measurements even through optical instruments. Protect the body, skin, and eyes with UV protective equipment.
- Attach warning labels on all products and systems that use UV LEDs.

Cleaning Precautions

- Do not use brushes or organic solvents for cleaning the LEDs.
- Perform electrical and optical measurements before and after cleaning to ensure optimal performance.

Static Electricity Precautions

- Ensure that equipment and machinery are properly grounded.
- Anti-electrostatic attire (wristbands, gloves, footwear, etc.) is recommended.
- Damage inspection is recommended while performing characteristics inspection of LEDs.

Disclaimers

Violumas is not responsible for any damages that result from inaccurate use of the recommended guidelines. The information compiled in this document is a result of careful review of reference materials and reliable sources. Violumas does not make any claims regarding warranty or guarantee. It is recommended that each customer consults the Violumas engineering team before engaging Violumas products in extreme applications where the failure of the LED and damage to human health may be possible. Each user assumes full responsibility for determining the suitability of the use of Violumas products in various applications. Disassembling Violumas products without consent is prohibited. No part of these documents may be reproduced in any form without prior written permission from Violumas. Please note that the data presented in this document is measured from the use of exclusive Flip Chip Opto patented products - the 3-PAD LED Flip Chip and the Pillar MCPCB.

VC12X1 Series 12-LED Light Bar COB

VC12X1 Series is UV LED Light Bar Chip on Board (COB) module with 12 chips bonded in a linear structure. Each COB is structured based on the patented 3-PAD LED Flip Chip mounted directly onto the Super Pillar MCPCB to further boost output efficiency and decrease the thermal resistance. The VC12X1 Series is ready for plug and play with no soldering required and is equipped with a 60° lens.

FEATURES & BENEFITS

- Dimensions: 304mm x 20mm
- Ready for plug and play (solder-free)
- Equipped with 60° fused silica lens
- TVS built in for ESD protection

THE VIOLUMAS DIFFERENCE

- 3-PAD flip chip structure
- Lowest thermal resistance at 0.075°C/W
- Minimal thermal decay with higher output
- Industry-leading reliability & lifetime



Electro-Optical Characteristics for UVA (T=25°C and I_F =700mA)

Part Number	Wavelength	Typ. Output	Forward Voltage	Power Consumption
VC12X1C45L6-405	405nm	12W	43.5V	30.5W
VC12X1C45L6-395	395nm	13W	43.5V	30.2W
VC12X1C45L6-385	385nm	12W	43.5V	30.2W
VC12X1C45L6-375	375nm	9W	43.5V	30.2W
VC12X1C45L6-365	365nm	6W	46.8V	30.8W

Absolute Maximum Ratings for UVA

Parameter	Symbol	Unit	Value
Forward Current	I _F	mA	1000
Reverse Voltage	V _R	V	60
Power	P _D	W	48
Junction Temperature	T _J	°C	120
Operating Temperature	T _{OPR}	°C	-30 ~ 85
Storage Temperature	T _{STG}	°C	-40 ~ 105

Reliability

Test	Condition	Test Duration	Test Failed/Tested
Thermal Shock	-45°C ~ 125°C	2000 Cycles	0/10

Electro-Optical Characteristics for UVB & UVC (T=25°C and I_F = 1400mA)

Part Number	Wavelength	Typ. Output	Forward Voltage	Power Consumption
VC12X1C48L6-310	310nm	1.35W	36.0V	50.4W
VC12X1C48L6-295	295nm	1.1W	36.0V	50.4W
VC12X1C48L6-275	275nm	1W	37.8V	52.9W
VC12X1C48L6-265	265nm	0.8W	38.4V	53.8W

Absolute Maximum Ratings for UVB & UVC

Parameter	Symbol	Unit	Value
Forward Current	I _F	mA	2000
Reverse Voltage	V _R	V	30
Power	P _D	W	84
Junction Temperature	T _J	°C	120
Operating Temperature	T _{OPR}	°C	-30 ~ 85
Storage Temperature	T _{STG}	°C	-40 ~ 105

Reliability

Test	Condition	Test Duration	Test Failed/Tested
Thermal Shock	-45°C ~ 125°C	2000 Cycles	0/10

Product Overview

COB modules are ready for plug and play with no soldering required. All Violumas COBs are equipped with connectors for direct wiring and TVS protection against ESD and voltage issues.

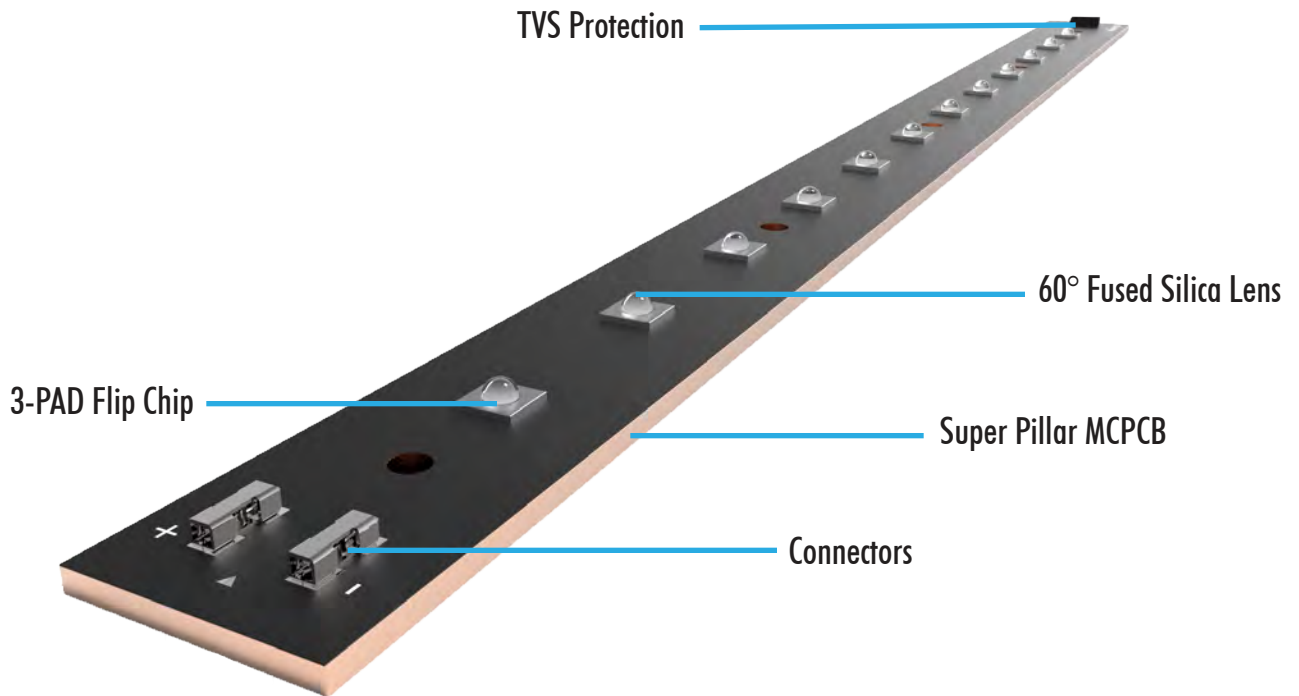

Mechanical Dimensions

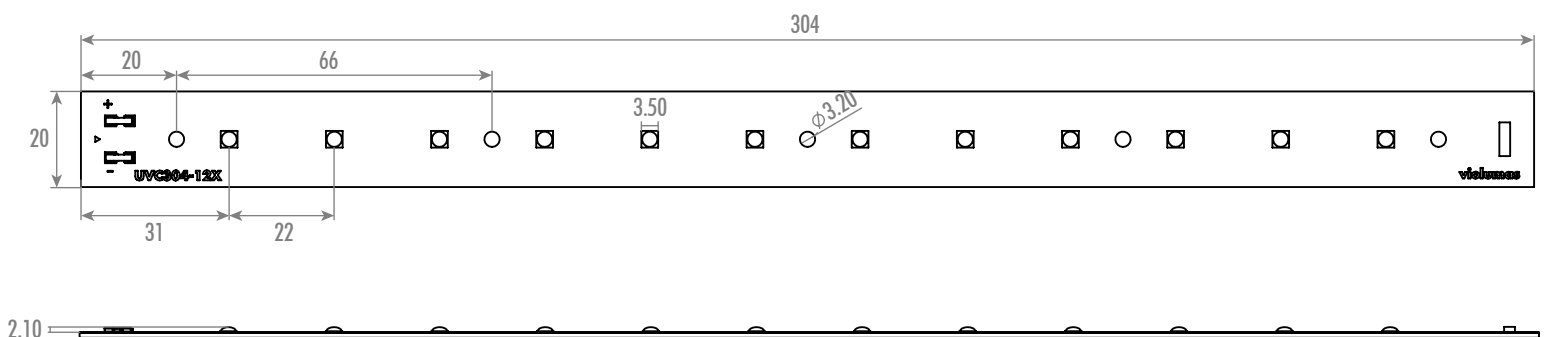

Please contact us for additional information regarding performance curves, irradiance maps, and suitable heatsinks/drivers for this product.

Handling & Usage Precautions

- Exhibit extreme care when handling LEDs. Do not touch the LED with bare hands as doing so may contaminate and affect the optical characteristics of the LED. When using tweezers, do not apply excessive force, especially to the glass lens. Do not drop the LED as doing so may cause product damage.
- Ensure that electrostatic discharge specifications are followed. Static electricity and surge voltages may cause product damage. Proper electrostatic discharge protection equipment, working machinery, and protected mounting equipment are recommended.
- Do not expose the LEDs to volatile organic compounds as well as hazardous, acidic, and corrosive substances during storage and operation to avoid product damage.
- Do not apply excess mechanical force and vibration while handling the product.
- Do not expose the product to sudden changes in temperature, high humidity levels, and condensation.
- Ensure that the PCB is suitable for the product and be wary of LED placement and possible PCB warpage.
- To avoid fault issues, do not couple any electrical wires to the metal substrate of the MCPCB or COB. If any electrical wires from the power source have contact with the MCPCB's metal base under power ON conditions, permanent damage may occur due to inner arcing within the 3-PAD LED structure.

Storage Precautions

- Perform soldering as soon as the moisture-proof packaging is opened.
- After the storage duration has exceeded the recommended time, products may need to be baked before soldering.
- Store all products in a controlled environment under 30° C free of dust. Do not expose the product to sudden changes in temperature, high humidity levels, and condensation.
- Please consult the Violumas engineering team for further information on storage precautions.

Eye Safety Precautions

- Avoid exposure to UV light during LED operation. Do not look directly into the UV light during LED operation. Do not look directly into the UV light during optical measurements even through optical instruments. Protect the body, skin, and eyes with UV protective equipment.
- Attach warning labels on all products and systems that use UV LEDs.

Cleaning Precautions

- Do not use brushes or organic solvents for cleaning the LEDs.
- Perform electrical and optical measurements before and after cleaning to ensure optimal performance.

Static Electricity Precautions

- Ensure that equipment and machinery are properly grounded.
- Anti-electrostatic attire (wristbands, gloves, footwear, etc.) is recommended.
- Damage inspection is recommended while performing characteristics inspection of LEDs.

Disclaimers

Violumas is not responsible for any damages that result from inaccurate use of the recommended guidelines. The information compiled in this document is a result of careful review of reference materials and reliable sources. Violumas does not make any claims regarding warranty or guarantee. It is recommended that each customer consults the Violumas engineering team before engaging Violumas products in extreme applications where the failure of the LED and damage to human health may be possible. Each user assumes full responsibility for determining the suitability of the use of Violumas products in various applications. Disassembling Violumas products without consent is prohibited. No part of these documents may be reproduced in any form without prior written permission from Violumas. Please note that the data presented in this document is measured from the use of exclusive Flip Chip Opto patented products - the 3-PAD LED Flip Chip and the Pillar MCPCB.